

Tool Rebels on Bikes

Screwdriving tools made by Wera





Bicycle Set 1

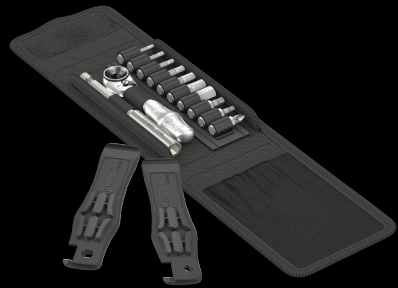

14-piece set, in folding pouch; 1x Wera Zyklus Mini 1 bit ratchet, drop-forged solid steel design; suitable for mounting bits with 1/4" external hexagon drive as per DIN ISO 1173-C 6.3 and E 6.3 and Wera connection series 1 and 4, inserting 1/4" sockets also possible by using the 870/1 Wera adapter; 1x universal holder (100 mm), stainless steel, with retaining ring and permanent magnet; 10 bits, tough, for universal use; 1x 9502 tyre jack with bit mounting, 1x tyre jack 903 with valve ejector.

05004170001		
⊙	8001 A	1x 1/4"x87,0
⊙⊙	3899/4/1	1x 1/4"x100
⊕	851/1 Z	1x PH 2x25
⊕	867/1 TORX®	1x TX 10x25; 1x TX 25x25
⊙	840/1 Z	1x 2,0x25; 1x 2,5x25; 1x 3,0x25; 1x 4,0x25; 1x 5,0x25; 1x 6,0x25; 1x 8,0x25
	9502	1x 105,0
	9503	1x 105,0
	Hook and Loop Fastener Strip 70	1x 50,0x70,0

Bicycle Set 2

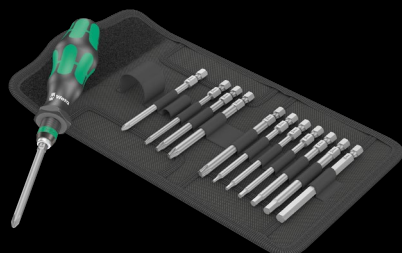

13-piece set, in a pouch; 1 816 R Kraftform bitholding screwdriver handle with Rapidaptor quick-release chuck, suitable for 1/4" hex bits as per DIN ISO 1173-C 6.3 and E 6.3 and Wera series 1 and 4; 12 bits, 89 mm long, tough, for universal use

05004171001		
⊙	816 R	1x 1/4"x119
⊕	851/4 Z	1x PH 1x89; 1x PH 2x89
⊕	867/4 Z TORX®	1x TX 10x89; 1x TX 20x89; 1x TX 25x89; 1x TX 30x89
⊙	840/4 Z	1x 2,0x89; 1x 2,5x89; 1x 3,0x89; 1x 4,0x89; 1x 5,0x89; 1x 6,0x89 ¹⁾
	Hook and Loop Fastener Strip 70	1x 50,0x70,0

¹⁾ Hexagonal blade

The tool set to go



The Bicycle Set 1 contains tools for the most popular screw profiles on road bikes, mountain bikes and e-bikes. Thanks to the compact textile-folding pouch, the set is also the ideal companion for cycling tours.

Lever tyre off the rim safely



With the glass fibre reinforced plastic tyre jacks, the tyres can be safely levered off the rim without damaging the rim. Lift off of the rim with one tyre jack, hook into a spoke and pull off the tyre with the second tyre jack. The two tyre jacks can be clicked together and are therefore not lost individually.

The 9502 tyre jack with bit mounting

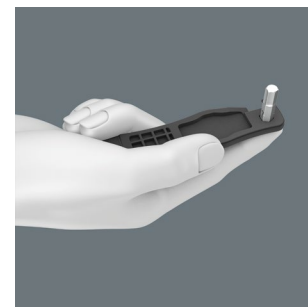

The 1/4" hexagon mounting in the 9502 tyre jack allows fixing of French valves on the side flats. In addition, a 1/4" bit can be inserted to use for light screw connections.

The 9503 tyre jack with valve ejector to deflate



The 9503 tyre jack is both valve ejector and deflater.



Bicycle Set 3



41-piece set

28 bits, 1x 813 bitholding screwdriver suitable for mounting bits with 1/4" external hexagon drive as per DIN ISO 1173-C 6.3 and Wera connection series 1, 1x Rapidaptor bit holder, 1x 870/1 adapter (1/4" hexagon to 1/4" square head), 7 sockets (1/4"), 1x Wera Zyklus Mini 1 bit ratchet, drop-forged solid steel design; suitable for mounting bits with 1/4" external hexagon drive as per DIN ISO 1173-C 6.3 and E 6.3 and Wera connection series 1 and 4, inserting 1/4" sockets also possible by using the 870/1 Wera adapter; 1x 9502 tyre jack with bit mounting, 1x tyre jack with valve ejector. 1x Bit-Check, empty, for reduced equipment, e.g. to take on bike tours. 1 robust textile pouch for neat storage.

05004172001		
□	8001 A	1x 1/4"x87,0
●	813	1x 1/4"x78
○	889/4/1 K	1x 1/4"x50
○	870/1	1x 1/4"x25 ¹⁾
●	8790 HMA	1x 5,5x23,0; 1x 6,0x23,0; 1x 7,0x23,0; 1x 8,0x23,0; 1x 10,0x23,0; 1x 13,0x23,0; 1x 15,0x23,0
+	851/1 TZ	1x PH 1x25; 2x PH 2x25; 1x PH 3x25
+	867/1 TZ TORX®	1x TX 10x25; 1x TX 15x25; 2x TX 20x25; 2x TX 25x25; 1x TX 27x25; 1x TX 30x25; 1x TX 40x25
+	800/1 TZ	1x 0,5x4,0x25; 1x 0,6x4,5x25; 1x 1,0x5,5x25
○	840/1 Z	1x 2,0x25; 1x 2,5x25; 1x 3,0x25; 1x 4,0x25; 1x 5,0x25; 1x 6,0x25; 1x 8,0x25
○	842/1 Z	1x 2,5x25; 1x 3,0x25; 1x 4,0x25; 1x 5,0x25; 1x 6,0x25
	9502	1x 105,0
	9503	1x 105,0
	Hook and Loop Fastener Strip 120	1x 50,0x120,0

¹⁾ With friction ball; for manual nut spinner sockets

Bicycle Set 3

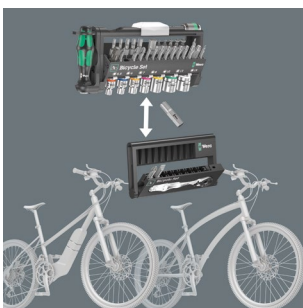

Bicycle Set 3 is a practical assortment for the independent execution of assembly work and repairs on road bikes, mountain bikes and e-bikes. Especially useful: a Bit-Check (empty) is also included, which can be equipped individually with tools on the way: less weight on bike rides.

Bicycle Set 3 A



38-piece set

One chain riveter, one chain fastener, 22 bits, one 813 bitholding screwdriver suitable for bits with 1/4" external hexagon drive as per DIN ISO 1173-C 6.3 and E 6.3 and Wera connection series 1, one universal holder, stainless steel, one Rapidaptor bitholding screwdriver, one 870/1 adapter (1/4" hexagon to 1/4" square head), 7 sockets (1/4"). One Wera Zyklon Mini 1 bit ratchet, drop-forged solid steel design; suitable for mounting bits with 1/4" external hexagon drive as per DIN ISO 1173-C 6.3 and Wera connection series 1 and 4; 1/4" sockets can also be used by adapting the Wera 870/1 adapter; one 9502 tyre jack with bit mounting, one 9503 tyre jack with valve ejector. One robust textile pouch for clean storage of the Tool-Check. One soft case with zip to take individual tools with you on the bike.

05004183001		
⊖	8001 A	1x 1/4"x87,0
⊙	813	1x 1/4"x78
⊙⊙	3899/4/1	1x 1/4"x100
⊙⊙	889/4/1 K	1x 1/4"x50
⊙⊙	870/1	1x 1/4"x25 ¹⁾
⊙	8790 HMA	1x 5,5x23,0; 1x 6,0x23,0; 1x 8,0x23,0; 1x 9,0x23,0; 1x 10,0x23,0; 1x 13,0x23,0; 1x 15,0x23,0
⊕	851/1 TZ	1x PH 1x25; 1x PH 2x25
⊕	867/1 TZ TORX®	1x TX 10x25; 1x TX 15x25; 1x TX 20x25; 1x TX 25x25; 1x TX 27x25; 1x TX 30x25
⊖	800/1 TZ	1x 0,5x4,0x25; 1x 0,6x4,5x25
⊖	840/1 Z	1x 2,0x25; 1x 2,5x25; 1x 3,0x25; 1x 4,0x25; 1x 5,0x25; 1x 6,0x25; 1x 8,0x25
⊖	842/1 Z	1x 2,5x25; 1x 3,0x25; 1x 4,0x25; 1x 5,0x25; 1x 6,0x25
	9502	1x 105,0
	9503	1x 105,0
	9513 Chain Tool	
	9512 Chain- Hook	
	9481	1x 203,0x85,0
	9480	1x 90,0x135,0
	Hook and Loop Fastener Strip 120	1x 50,0x120,0

Zyklon Mini tool sets

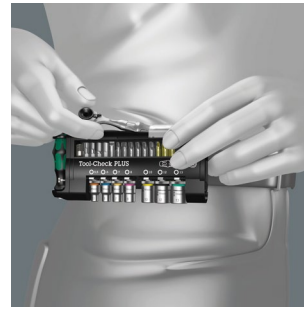

Available in a set with the dependable Wera Bit-Check with socket adaptor and belt clip. Simple fitting and removal of tools. Very robust and a long service life.

The Bicycle Set 3 a



The Bicycle Set 3 A is the practical assortment for independently carrying out assembly work and repairs on road bikes, mountain bikes and e-bikes. Particularly practical: one small case with zip to take individual tools with you in your jersey pocket. Less weight on bike tours.

Chain tools

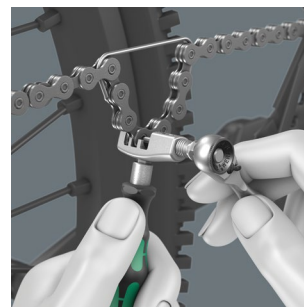

With the included chain tools, chains can be loosened and reconnected; for opening and closing bicycle chains. Suitable for single-speed chains, up to 12-speed.

Safely lever the tyres off of the rim



With the glass fibre reinforced plastic tyre jacks, the tyres can be safely levered off the rim without damaging the rim. Lift off of the rim with one tyre jack, hook into a spoke and pull off the tyre with the second tyre jack. The two tyre jacks can be clicked together and are therefore not lost individually.

Soft case with zip



The textile case fits perfectly into jersey pockets and is, therefore, also ideal for racing cyclists without panniers or saddle bags. On the back, there are also two convenient loops for CO₂ cartridges.



Bicycle Set 4







9-piece set in pouch

Application: Hexagonal socket screws and TORX® screws

Design: BlackLaser surface, durable plastic sleeve. The contrasting inscriptions on the colour-coded sleeves mean that it is easy to recognise the correct sizes and this makes it simpler to find the right tool.

Tip: 950 SPKL HF: Hex-Plus, ball-end hexagon on long arm, with holding function for hexagonal socket screws; 950 SPKL: Hex-Plus, ball-end hexagon on long arm, without holding function; 967 SXL HF: With holding function for TORX® screws to Acument Intellectual Properties specification.



	
05004173001	
	950 SPKL 1x 2,0x101; 1x 2,5x112 Multicolour
	950 SPKL HF 1x 3,0x123; 1x 4,0x137; 1x 5,0x154; Multicolour 1x 6,0x172; 1x 8,0x195
	967 SXL HF 1x TX 10x112; 1x TX 25x154 TORX® Multi-colour
	Hook and Loop Fastener Strip 70 1x 50,0x70,0



HEX-PLUS

Hex-Plus



Hexagon screws can endure a problem because the contact surfaces delivering the power from the conventional tool, is transferred to the screw via very small surface areas. The consequence: the screw can become damaged (rounding out). Hex-Plus tools have a greater contact surface that

prevents this from happening! At the same time, as much as 20 % more torque can be applied. Good to know: Hex-Plus tools fit into every standard hexagon socket screw!



HOLDING
FUNCTION

L-keys with holding function for hexagon socket screws



The clamping of the screw is achieved by a flexible locking ball. The holding function is especially helpful in confined, hard-to-reach spaces, where there is no room for a second hand to secure the screw on the tool.



Compact shape

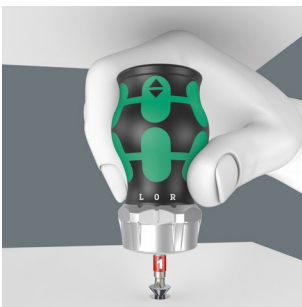

With its compact handle shape and the short blade, the Kraftform Stubbies are particularly suitable for working in confined screwdriving situations.

Swiveling bit magazine

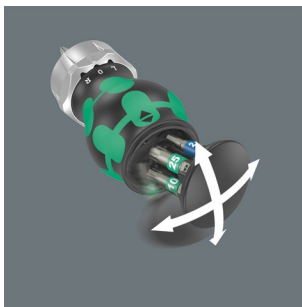

The swiveling bit magazine allows for the bits to be removed easily in almost any situation and cannot be lost. The bits are safely stored.



TAKE IT EASY
TOOL FINDER

Take it Easy Tool Finder

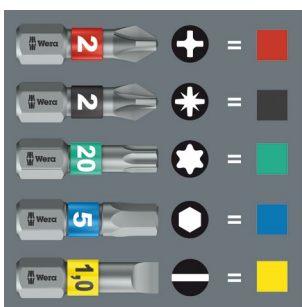

Take it Easy Tool Finder with colour coding according to profiles and size stamp – for simple and rapid accessing of the required tool.

Bicycle Set 5

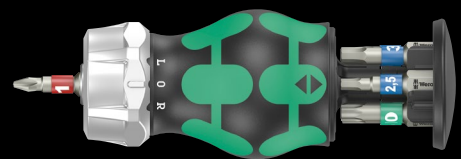

Application: Suitable for bits with 1/4" external hexagon drive as per DIN ISO 1173-C 6.3 and Wera connection series 1

Design: Ratchet, fine toothing for a low return angle, reversible ring (right, fixed, left); 1/4" hexagonal socket mounting, magnetic; 7 bits; stainless steel to prevent extraneous rust, torsion shape against premature wear. Take it Easy Tool Finder: With size stamping and colour coding by tip to help you find the required bit easily.

Handle: Kraftform Stubby with anti-roll protection, multi-component, integrated magazine

05004185001		
⊕	3851/1 TS	1x PH 1x25
⊗	3867/1 TS TORX®	1x TX 10x25; 1x TX 25x25
○	3840/1 TS	1x 2,5x25; 1x 3,0x25; 1x 4,0x25; 1x 5,0x25



Bicycle Set 6

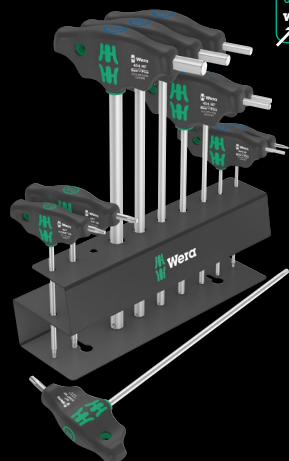

Application: Hexagonal socket screws, with holding function at the long arm from size 3; TORX®, with holding function at the long arm for TORX® screws as per Acument Intellectual Properties specifications

Design: With Take it Easy Tool Finder: Colour coding by profile (blue = hexagonal socket, green = TORX®) and size stamping. 10-piece set in a box, plus 1 rack

		
05004174001		
○ 454		1x 2,5x100
○ 454 HF		1x 3x100; 1x 4x150; 1x 5x150; 1x 6x200; 1x 8x200; 1x 10x200
⊗ 467 TORX® HF		1x TX 10x100; 1x TX 20x100; 1x TX 25x200



Bicycle Set 7

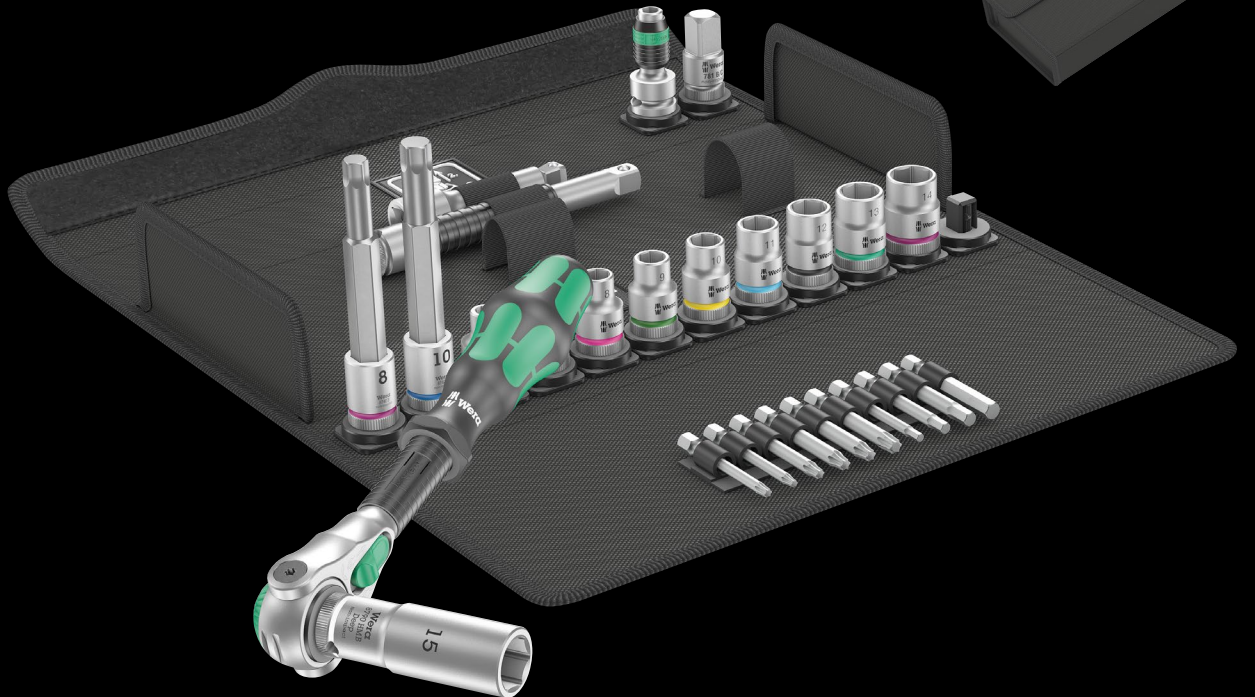

27-piece set; in surface-friendly, compact and extremely robust textile box. Small size and low weight for better mobility.

1 Zyklop Speed ratchet with $\frac{3}{8}$ " drive, 10 Zyklop sockets, 2 Zyklop bit sockets with 30 mm and extra slim profile area for better accessibility in tight workspaces, with Take it Easy Tool Finder: Colour coding by size. 1 Zyklop extension (short) with fast-rotating sleeve, 1 Wobble extension, 1 bit adapter, 1 connection part $\frac{3}{8}$ " external square head to $\frac{1}{2}$ " external square head, 10 bits, tough, for universal use. Incredibly compact set arrangement for many tools in a tight space thanks to the highly robust and durable textile box. Can be placed in an upright position for clearly arranged storage in the workshop shelf. Additional surface protection thanks to textile outer material. Low weight and small size for better mobility.

05004175001		
□	8000 B	1x $\frac{3}{8}$ "x199,0
●	8790 HMB	1x 6,0x29,0; 1x 7,0x29,0; 1x 8,0x29,0; 1x 9,0x29,0; 1x 10,0x29,0; 1x 11,0x29,0; 1x 12,0x29,0; 1x 13,0x29,0; 1x 14,0x29,0
●	8790 HMB Deep	1x 15,0x64,0
○	8740 B	1x 8,0x100,0; 1x 10,0x100,0
○	8794 B	1x $\frac{3}{8}$ "x76,0
○	8784 B1	1x $\frac{1}{4}$ "x $\frac{3}{8}$ "x44,0
○	8794 SB	1x $\frac{3}{8}$ "x125,0
○	781 B	1x 781 B/C, $\frac{1}{2}$ "x36,0x $\frac{3}{8}$ "
○	840/4 Z	1x 3,0x50; 1x 4,0x50; 1x 5,0x50; 1x 6,0x50 ¹⁾
⊕	867/4 Z TORX®	1x TX 10x50; 1x TX 15x50; 1x TX 20x50; 1x TX 25x50; 1x TX 27x50; 1x TX 30x50

¹⁾ Hexagonal blade



FLEXIBLE HEAD

Pivots freely



both to the right and left, ensure safe working without any slipping of the ratchet head.

The ratchet head of the Zyklop Speed pivots freely and can be locked into any defined position by using the slide switch that is positioned on either side. It is even possible to work in very confined and difficult-to-access areas with enhanced hand clearance. The predefined locking at 0°, 15° and 90°,

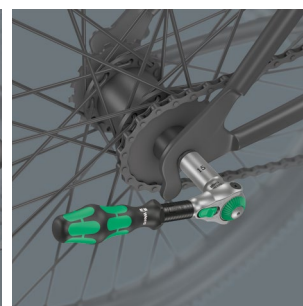

Bicycle Set 8



wera.de



7-piece set

Folding pouch with 100 mm/107 mm long bit sockets

7 Zyklop bit sockets with $\frac{3}{8}$ " drive; with 30 mm and extra slim profile area for better accessibility in tight workspaces. Take it Easy Tool Finder: With colour coding by size as well as size stamping - to help you find the required bit socket quickly and easily.

05004176001		
♻️	8767 B	1x TX 25x107,0; 1x TX 30x107,0
⊙	8740 B	1x 4,0x107,0; 1x 5,0x107,0; 1x 6,0x107,0; 1x 8,0x100,0; 1x 10,0x100,0
	Hook and Loop Fastener Strip 120	1x 50,0x120,0

30 mm long and extra slim profile area

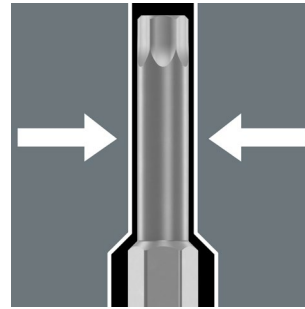

The bit sockets have a 30 mm long and extra slim profile area. This makes even couplings in tight work spaces easily accessible.



Bicycle Set 9



wera.de



9 bits; stainless steel to prevent extraneous rust, torsion shape against premature wear. 1x Wera Zyklop Mini 1 bit ratchet, drop-forged solid steel design; suitable for mounting bits with $\frac{1}{4}$ " external hexagon drive as per DIN ISO 1173-C 6.3 and E 6.3 and Wera connection series 1 und 4; inserting $\frac{1}{4}$ " sockets also possible by using the 870/1 Wera adapter

05004177001		
⊙	8001 A	1x $\frac{1}{4}$ "x87,0
+	3851/1 TS	1x PH 2x25
♻️	3867/1 TS TORX®	1x TX 10x25; 1x TX 25x25
⊙	3840/1 TS	1x 2,0x25; 1x 2,5x25; 1x 3,0x25; 1x 4,0x25; 1x 5,0x25; 1x 6,0x25 ¹⁾

¹⁾ Without Torsion zone



Stainless Steel Bits



Wera stainless steel bits are manufactured out of stainless steel so unsightly rust can be avoided. The stainless steel bits from Wera are vacuum ice-hardened and have the hardness and strength needed for screw connections. There are no limitations to the industrial applications they are suitable for.

Is such a small tool sufficiently resilient?



The Zyklop Mini 1 can withstand at least 65 Nm. That is far more power than can normally be transferred to such a small tool.



BICYCLE

6003 Joker Pedal



The extra thin pedal ring spanner (6003 Joker 15 Pedal) is ideal for narrow installation spaces.



For very tight spaces

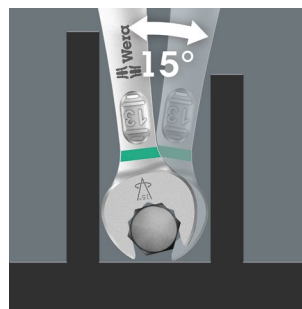

The Joker 6003 ring spanner with its special mouth geometry – mouth side pivoted by 7.5° and the double hexagon profile – doubles the placement possibilities when repeatedly turning the wrench 180° around the longitudinal axis. Bolts and screw heads can be "accessed" every 15°. The

Joker 6003 will automatically find the respective placement point after every turn.

Double-hex geometry

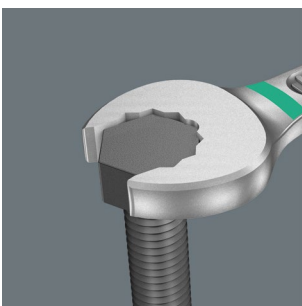

The double hexagon geometry on the mouth and ring sides secures the positive connection with the screw head or bolt and reduces the risk of slipping.

Joker 6003: Tilted ring side

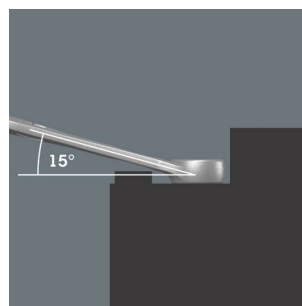

The ring side is tilted at 15° to the tool axis to prevent injury.

Bicycle Set 10



Ring spanner set, mouth side pivoted by 7.5°

5-piece set

In robust pouch

05004178001	
	6003 Joker 1x 8x115; 1x 9x120; 1x 10x125; 1x 13x160
	6003 Joker Pedal 1x 15x174
	Hook and Loop Fastener Strip 120 1x 50,0x120,0

Bicycle Set 12



Ring spanner set, mouth side pivoted by 7.5°

12-piece set

In robust pouch

05004181001	
	6003 Joker 1x 6x105; 1x 7x110; 1x 8x115; 1x 9x120; 1x 10x125; 1x 11x135; 1x 12x148; 1x 13x160; 1x 14x167; 1x 16x182; 1x 17x190
	6003 Joker Pedal 1x 15x174

Bicycle Set 11

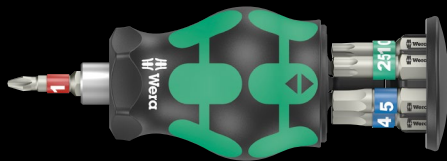

Application: Suitable for bits with 1/4" external hexagon drive as per DIN ISO 1173-C 6.3 and Wera connection series 1

Design: Bit holder with strong permanent magnet; 7 bits; stainless steel to prevent extraneous rust, torsion shape against premature wear. Take it Easy Tool Finder: With size stamping and colour coding by tip to help you find the required bit easily.

Handle: Kraftform Stubby with anti-roll protection, multi-component, integrated magazine

05004179001	
+	3851/1 TS 1x PH 1x25
T	3867/1 TS TORX® 1x TX 10x25; 1x TX 25x25
○	3840/1 TS 1x 2,5x25; 1x 3,0x25; 1x 4,0x25; 1x 5,0x25

Handle with integrated bit magazine

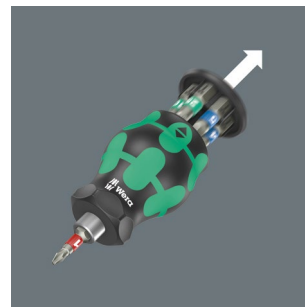

The handle can be opened and thus gives access to the six bits contained in the magazine.

Bit holder with magnet



The magnet ensures that the bit is securely seated in the holder.



Lever tyres off the rim safely



With the glass fibre reinforced plastic tyre jacks, the tyres can be safely levered off the rim without damaging the rim. Lift off of the rim with one tyre jack, hook into a spoke and pull off the tyre with the second tyre jack. The two tyre jacks can be clicked together and are therefore not lost individually.

The 9502 tyre jack with bit mounting

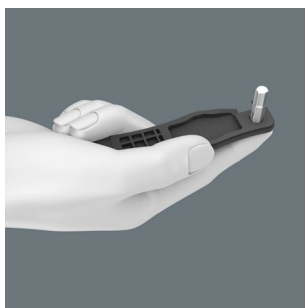

The 1/4" hexagon mounting in the 9502 tyre jack allows fixing of French valves on the side flats. In addition, a 1/4" bit can be inserted to use for light screw connections.

The 9503 tyre jack with valve ejector to deflate



The 9503 tyre jack is both valve ejector and deflater.

Bicycle Set 13



2-piece set

With the glass fibre reinforced plastic tyre jacks, the tyres can be safely levered off the rim without damaging the rim.

1x 9502 tyre jack with 1/4" bit mounting

1x 9503 tyre jack with valve ejector for Schläverand (French) valves and bleeder valve for car valves

		
05004184001		
9502	1x	105,0
9503	1x	105,0

The Wera 4-in-1 bits

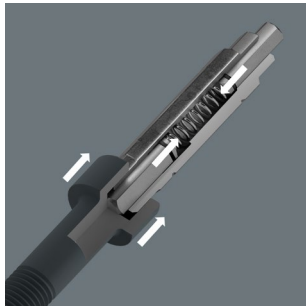

Four screw sizes can be operated with the 4-in-1 bits 9506 and 9507. The 4-in-1 bit 9506 for four sizes of hexagonal socket screws (3.0; 4.0; 5.0; 6.0), the 4-in-1 bit 9507 for three sizes of hexagonal socket screws (2.5; 5.0; 6.0) and one size of TORX® screws (TX 25).

In order to use the larger profile, continuously press against the spring tension while screwdriving so that the smaller profile is countersunk and the larger profile can be used.

Compact

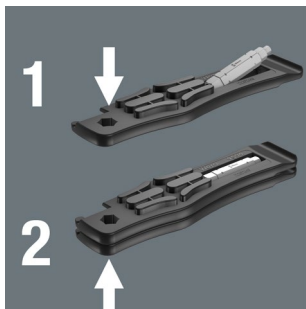

The 4-in-1 bit is clipped into the 9504 tyre jack. The 9505 tyre jack can be attached so that the jack and bit form a compact package.

Bicycle Set 15



5-piece set

With the glass fibre reinforced plastic tyre jacks, the tyres can be safely levered off the rim without damaging the rim.

Two 9504 tyre jacks with 1/4" bit mounting

One 9505 tyre jack with valve ejector for French valves (Sclaverand) and bleeder valve for car valves

One bit 9506 (4-in-1) for hexagonal socket screws sizes 3.0; 4.0; 5.0; 6.0

One bit 9507 (4-in-1) for hexagonal socket screws sizes 2.5; 5.0; 6.0 and TORX® screws size TX 25

		
05004182001		
	9504	2x 105,0
	9505	1x 105,0
⊙⊙	9506	1x 3,0; 4,0; 5,0; 6,0x37
⊙⊙⊙	9507	1x 2,5; 5,0; 6,0xTX 25x37



Bicycle Big Pack 1



14-piece screwdriver set for bicycle applications

2x 354 Hex-Plus screwdrivers for hexagonal socket screws, 5x 454 HF T-handle screwdrivers with long and short arm with holding function for hexagonal socket screws at the long arm, 1x 367 screwdriver for TORX® screws, 2x T-handle screwdrivers with long and short arm with holding function for TORX® screws at the long arm as per Acument Intellectual Properties specifications, 2x 350 PH screwdrivers with Lasertip for Philips-head screws; with Take it Easy Tool Finder: Colour coding by profile and size stamping, 2x 932 A chiseldrivers with pound-thru hexagon blade and integrated impact cap. 2 racks for storage.

05004190001		
○	354	1x 2,0x75; 1x 2,5x75
○	454 HF	1x 3x100; 1x 4x150; 1x 5x150; 1x 6x200; 1x 8x200
⊕	367 TORX®	1x TX 10x80
⊕	467 TORX® HF	1x TX 20x100; 1x TX 25x200
⊖	932 A	1x 1,0x5,5x100; 1x 1,2x7,0x125
⊕	350	1x PH 1x80; 1x PH 2x100

Second arm



The additional short arm, which emerges laterally from the handle, allows the transmission of extremely high torques by using the long arm as a lever.



Screwdrivers 350 PH: With Lasertip



A precisely-focused laser creates a sharp-edged surface structure. This laser treatment results in an edge hardness of up to 1000 HV 0.3. Wera Lasertip "bites" itself into the screw head and prevents any slips out of the recess.

9532 Chain riveter set for workshops



20-piece set

One Wera Zyklop Mini 1 bit ratchet, drop-forged solid steel design; suitable for mounting bits with 1/4" external hexagon drive as per DIN ISO 1173-C 6.3 and E 6.3 and Wera connection series 1 and 4, one 816 R bitholding screwdriver, one chain riveter, one chain fastener, spare parts set chain riveter pin, one chain lock tool, 10 bits with 89 mm length, 2 bits with 25 mm length, one robust folding pouch



05136042001		
○	8001 A	1x 1/4"x87,0
●	816 R	1x 1/4"x119
+	851/4 Z	1x PH 1x89; 1x PH 2x89
⊗	867/4 Z TORX®	1x TX 10x89; 1x TX 25x89
○	840/4 Z	1x 2,0x89; 1x 2,5x89; 1x 3,0x89; 1x 4,0x89; 1x 5,0x89; 1x 6,0x89 ¹⁾
○	840/1 Z	1x 5,0x25; 1x 8,0x25
9512 Chain-Hook		
9513 Chain Tool		
	9533 Quick-release bike chain tool	1x 167,5
	9534	3x 15,0

¹⁾ Hexagonal blade

Chain lock tool

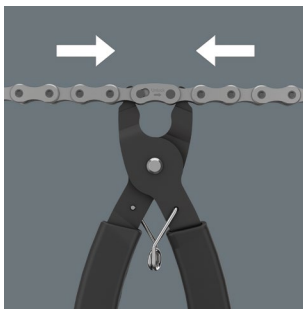

The chain lock tool makes it easier to open lockable chain locks for cleaning or replacing chain links.

Chain tools

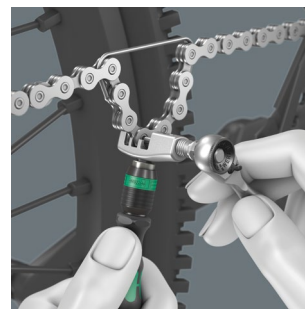

With the included chain tools, chains can be loosened and reconnected; for opening and closing bicycle chains. Suitable for single-speed chains, up to 12-speed.

9523 Chain riveter spare part kit

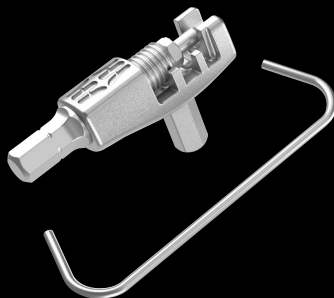

05136039001	
	9513 Chain Tool
	9512 Chain-Hook

9534/3 Spare part kit rivet pin for 9513 chain riveter



05130006001	
	9534
	3x 15,0

Safe-Torque A 2 torque wrench with 1/4" hexagon drive, 2-12 Nm



Application: For controlled clockwise and counterclockwise torque operation; tightening and loosening with or without torque

Torque range: 2-12 Nm

Suitable for: 1/4" bits with 1/4" external hexagon drive as per DIN ISO 1173-C 6.3 and E 6.3 and Wera connection series 1 and 4

Precision: Accuracy $\pm 10\%$ of the set value

Design: With 1/4" hexagonal socket drive, torque wrench, disengageable torque function (Torque Lock function); 72 teeth; low return angle of 5°; easy setting and saving of the desired torque value, with audible and tactile locking when the scale values are reached, slip-over release mechanism when the set torque is reached

Handle: Ergonomic 2-component handle

	Nm	Nm	lbf. ft.	mm	mm	mm	mm	mm	mm	mm	mm	mm	mm	mm	mm
05075801001	1/4"	2-12	0,10	2-9	244	94	38,5	31,6	23,7	9 39/64"	3 45/64"	1 33/64"	1 15/64"	15/16"	



Slide-over mechanism prevents application of excessive torques

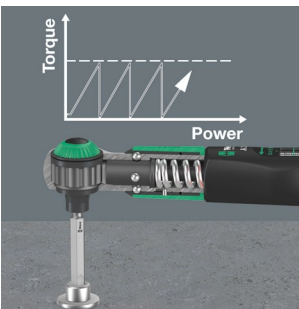

The Safe-Torque A2 torque wrench is equipped with a slide-over mechanism. Once the set torque has been reached, the tool cannot be overtightened, so that excessive torque cannot be applied.



For clockwise and counterclockwise operation



The Safe-Torque torque wrench is suitable for clockwise and counterclockwise operation with a set torque. When the Torque Lock function is deactivated, tightening and loosening is enabled without torque.



Torque Lock function



The torque function can be deactivated. The Safe-Torque torque wrench can then also be used as a standard ratchet with high loosening moments and for applications with defined angles of rotation.

For 1/4" bits

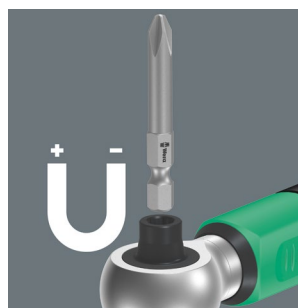

The Safe-Torque A 2 torque wrench has a 1/4" bit mounting with a strong permanent magnet and is suitable for bits with 1/4" external hexagon drive as per DIN ISO 1173-C 6.3 and E 6.3 and Wera connection series 1 and 4.

Safe-Torque A 2 Set 1, 1/4" hexagonal, 2-12 Nm

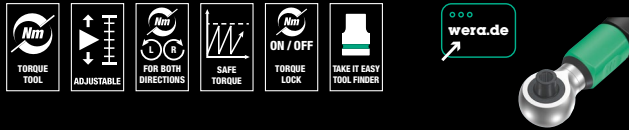

23-piece set; in a surface-friendly, compact and extremely robust textile box. Small size and low weight for better mobility.

1 Safe-Torque A 2 torque wrench with 1/4" hexagonal socket drive, measuring range 2-12 Nm; for controlled clockwise and counterclockwise torque operation; tightening and loosening with or without torque, disengageable torque function (Torque Lock function); 72 teeth; low return angle of 5°; easy setting and saving of the desired torque value, with audible and tactile locking when the scale values are reached, slip-over release mechanism when the set torque is reached; ergonomic 2-component handle; 9 Zyklop sockets, 12 tough bits (1/4", 50 mm long), one connection part for sockets (1/4" external hexagon to 1/4" external square head)

05075832001	
●	Safe-Torque A 2 1x 1/4", 2-12 Nm
●	8790 HMA 1x 5,5x23,0; 1x 6,0x23,0; 1x 7,0x23,0; 1x 8,0x23,0; 1x 9,0x23,0; 1x 10,0x23,0; 1x 11,0x23,0; 1x 12,0x23,0; 1x 13,0x23,0
○ ○	870/1 1x 1/4"x25 ¹⁾
+	851/4 Z 1x PH 2x50
⊕	867/4 Z TORX® 1x TX 10x50; 1x TX 15x50; 1x TX 20x50; 1x TX 25x50; 1x TX 27x50; 1x TX 30x50
○	840/4 Z 1x 2,5x50; 1x 3,0x50; 1x 4,0x50; 1x 5,0x50; 1x 6,0x50 ²⁾
	Hook and Loop Fastener Strip 240

¹⁾ With friction ball; for manual nut spinner sockets

²⁾ Hexagonal blade

7515/7 Kraftform Safe-Torque Speed Bicycle 1



7-piece set

Folding pouch with one torque screwdriver with easy quick torque setting and 6 tough bits (50 mm length), with Wera "Take it easy" Tool finder: size stamping and colour coding by output to help you find the required bit easily

05075850001	
7515	1x 1/4"x2,0x3,0x4,0x5,0x6,0x147,5
⊕	867/4 Z TORX® 1x TX 10x50; 1x TX 25x50 Take it easy
○	840/4 Z Hex-Plus Take it easy 1x 2,5x50; 1x 3,0x50; 1x 4,0x50; 1x 5,0x50

7515 Kraftform Safe-Torque Speed Torque screwdriver, 2-6 Nm

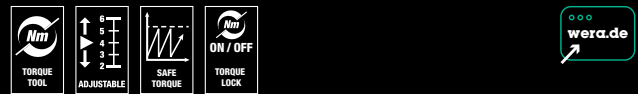

Application: Suitable for bits with 1/4" external hexagon drive

Design: Five selectable maximum tightening torques and one fixed position; bit mounting with ±10 % precision. Digital torque value display. Reliable signal when the set torque is reached.

Handle: Kraftform with anti-roll protection, multi-component

05075815001	
1/4"	2,0 Nm 3,0 Nm 4,0 Nm 5,0 Nm 6,0 Nm 147,5 mm





2.5-25 N·m
2-16 Nm

Wencc
A5

0 2.5 5 10 15 20 25

Bicycle Set Torque 1, 2.5-25 Nm

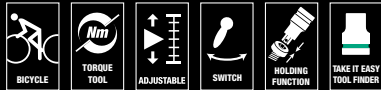

16-piece set; in a surface protecting, compact and extremely robust textile box; low volume and weight for simplified mobility.

1 Click-Torque torque wrench A 5 with 1/4" square drive, covering a range of 2.5 Nm-25 Nm, accuracy $\pm 4\%$ of the set value, as per DIN EN ISO 6789-1: 2017-07, for clockwise torque control, reversible ratchet, 45 teeth, easy setting and saving of the desired torque value, with audible and tactile locking when the scale values are reached (fine scale only in Newton meters), audible and tactile release mechanism when the set torque value is reached, ergonomic 2-component handle, 4 Zyklop sockets, with 1/4" drive, 4 Zyklop bit sockets for TORX® screws, with 1/4" drive, 7 bit sockets for hexagon socket screws with 1/4" drive with holding function; Take it Easy Tool Finder: Colour coding to enable the desired bit socket to be easily selected

05004180001	Click-Torque A 5	1x 1/4", 2,5-25 Nm
●	8790 HMA	1x 10,0x23,0; 1x 13,0x23,0; 1x 14,0x23,0; 1x 15,0x23,0
⊗	8767 A	1x TX 10x28,0; 1x TX 20x28,0; 1x TX 25x28,0; 1x TX 30x28,0
○	8740 A HF	1x 3,0x28,0; 1x 4,0x28,0; 1x 5,0x28,0; 1x 5,0x100,0; 1x 6,0x28,0; 1x 6,0x100,0; 1x 8,0x28,0
	Hook and Loop Fastener Strip 240	1x 50,0x240,0



Torque wrench with release mechanism

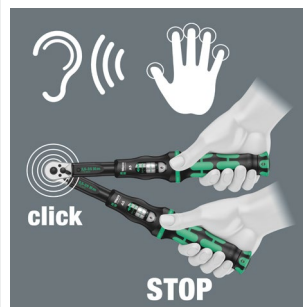

When the set torque value is reached, an audible and tactile mechanism triggers.

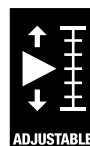

Simple setting of the torque wrench



With audible and tactile clicks when adjusting the scale values.

Series 7400 Kraffform adjustable torque screwdrivers (0.1-3.0 Nm) with Rapidaptor quick-release chuck



Application: Suitable for 1/4" DIN ISO 1173-C 6.3 and E 6.3 hexagon insert bits and Wera Series 1 and 4

Design: Rapidaptor rapid-in, rapid-out, rapid-spin, chuck-all and single-hand technology

Accuracy: ±6 % (DIN EN ISO 6789). Numerical torque valuescale. Reliable slipping mechanism and acoustic signal when reaching the set torque.

Handle: Kraffform with non-roll feature, multi-component



	Art.No.	1/4"	Nm	Nm	mm	mm	mm
05074770001 ¹⁾	7430	1/4"	0,10-0,34	0,015	89	142	5 7/16"
05074772001 ¹⁾	7431	1/4"	0,30-1,00	0,05	89	142	5 7/16"
05074774001 ¹⁾	7432	1/4"	0,90-1,50	0,05	89	142	5 7/16"
05074700001	7440	1/4"	0,3-1,2	0,05	105	155	6"
05074701001	7441	1/4"	1,2-3,0	0,10	105	155	6"

¹⁾ With attachable magnifying glass, dramatically improving visibility.

Click-Torque A 5 torque wrench with reversible ratchet, 2.5-25 Nm

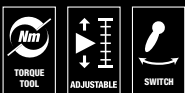

Application: For clockwise torque-control

Precision: ± 4% of set value, as per DIN EN ISO 6789-1: 2017-07

Design: With 1/4" square drive, reversible ratchet, 45 teeth; easy setting and saving of the desired torque value, with audible and tactile locking when the scale values are reached (fine scale only in Newton meters), audible and tactile release mechanism when the set torque value is reached

Handle: Ergonomic 2-component handle

		Nm	Nm	lbf. ft.	mm	mm	mm	mm	mm	mm	mm	mm	mm	mm
05075604001	1/4"	2,5-25	0,10	1-18	290	121	42	25	11,5	11 27/64"	4 49/64"	1 21/32"	1"	7/16"

Click-Torque A 6 torque wrench with reversible ratchet, 2.5-25 Nm

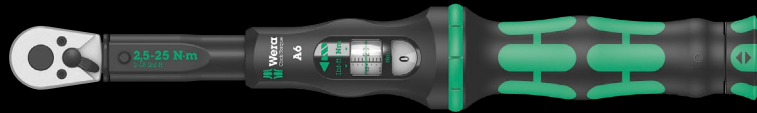
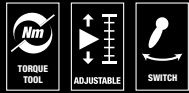

Application: For clockwise torque-control

Precision: ± 4% of set value, as per DIN EN ISO 6789-1: 2017-07

Design: With 1/4" hex drive, reversible ratchet, 45 teeth; easy setting and saving of the desired torque value, with audible and tactile locking when the scale values are reached (fine scale only in Newton meters), audible and tactile release mechanism when the set torque value is reached

Handle: Ergonomic 2-component handle

	Nm		lbf. ft.	mm	mm	mm	mm	mm	mm	mm	mm	mm	mm	
05075605001	1/4"	2,5-25	0,10	1-18	290	121	42	25	11,5	11 27/64"	4 49/64"	1 21/32"	1"	7/16"

Click-Torque A 6 Set 1, 2.5-25 Nm

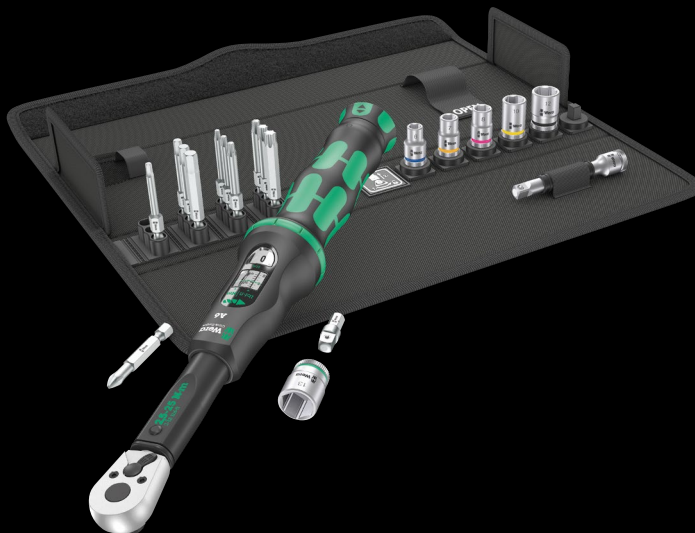
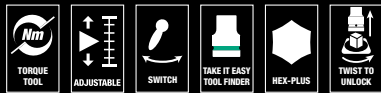

20-piece set; in a surface protecting, compact and extremely robust textile box; low volume and weight for simplified mobility.

1 Click-Torque A 6 torque wrench with 1/4" hexagon drive, covering a range of 2.5 Nm-25 Nm, accuracy ± 4% of the set value, as per DIN EN ISO 6789-1: 2017-07, for clockwise torque control, reversible ratchet, 45 teeth, easy setting and saving of the desired torque value, with audible and tactile locking when the scale values are reached (fine scale only in Newton meters), audible and tactile release mechanism when the set torque value is reached, ergonomic 2-component handle, 6 Zyklop sockets, 1 adapter 1/4" hexagon to 1/4" square, 1 Zyklop extension with free-turning sleeve, short, 11 bits

05130110001	Click-Torque A 6 1x 1/4", 2,5-25 Nm
+	851/4 TZ 1x PH 2x50
⊗	867/4 Z TORX® 1x TX 15x50; 1x TX 20x50; 1x TX 25x50; 1x TX 27x50; 1x TX 30x50; 1x TX 40x50
○	840/4 Z 1x 3,0x50; 1x 4,0x50; 1x 5,0x50; 1x 6,0x50 ¹⁾
○	870/1 1x 1/4"x25 ²⁾
⊗	8794 SA 1x 1/4"x75,0
⊗	8790 HMA 1x 6,0x23,0; 1x 7,0x23,0; 1x 8,0x23,0; 1x 10,0x23,0; 1x 12,0x23,0; 1x 13,0x23,0
	Hook and Loop Fastener Strip 240 1x 50,0x240,0

¹⁾ Hexagonal blade

²⁾ With friction ball; for manual nut spinner sockets

Click-Torque B 1 torque wrench with reversible ratchet, 10-50 Nm

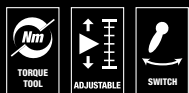

Application: For clockwise torque-control

Precision: ± 3% of set value, as per DIN EN ISO 6789-1: 2017-07

Design: With 3/8" square drive, reversible ratchet, 45 teeth; easy setting and saving of the desired torque value, with audible and tactile locking when the scale values are reached (fine scale only in Newton meters), audible and tactile release mechanism when the set torque value is reached

Handle: Ergonomic 2-component handle

	Nm		lbf. ft.	mm	mm	mm	mm	mm	mm	mm	mm	mm	mm	
05075610001	3/8"	10-50	0,25	8-36	360	140	47	35	16,5	14 11/64"	5 53/64"	1 27/32"	1 3/8"	5/8"

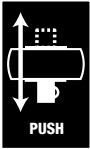

For right and left direction

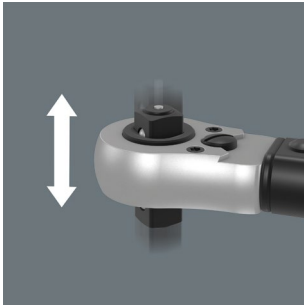

The Click-Torque wrenches Push R/L are suitable for clockwise and anti-clockwise torque-control. Very smooth change of direction thanks to captive square head insert.

Release mechanism

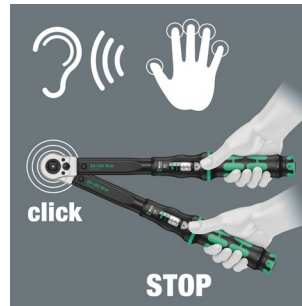

When the set torque value is reached, an audible and tactile mechanism triggers.

Click-Torque C 2 Push R/L adjustable torque wrench for clockwise and anti-clockwise torque-control, 20-100 Nm

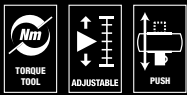

Application: For clockwise and anti-clockwise torque-control

Precision: Precise to $\pm 3\%$ of the set value, as per DIN EN ISO 6789-1:2017-07

Design: With $1/2$ " square head drive with socket locking, square head insert to change the tightening direction, fine-teethed ratchet mechanics, 45 teeth; easy setting and saving of the desired torque, with audible and tactile locking when the scale values are reached (fine scale only in Newton meters), audible and tactile release mechanism when the torque value is reached

Handle: Ergonomic 2-component handle

	Nm	Nm	lbf. ft.	mm	mm	mm	mm	mm	mm	mm	mm	mm	mm	mm
05075625001	$1/2$ "	20-100	0,5	15-73	405	140	47	43	18,5	$15\ 15/16$ "	$5\ 39/64$ "	$1\ 27/32$ "	$1\ 11/16$ "	$45/64$ "

Click-Torque X 1 torque wrench for insert tools, 2,5-25 Nm



Application: For right and left-handed use

Precision: $\pm 4\%$ of set value, as per DIN EN ISO 6789-1: 2017-07

Design: For 9x12 mm interchangeable insert tools; easy setting and saving of the desired torque value, with audible and tactile locking when the scale values are reached (fine scale only in Newton meters), audible and tactile release mechanism when the set torque value is reached

Handle: Ergonomic 2-component handle

						S_k	l_k									
	Nm	Nm	lbf. ft.	mm	mm	mm	mm	mm	mm	mm	mm	mm	mm	mm	mm	
05075651001	9x12	2,5-25	0,10	1-18	292	17,5	240,0	121	42	24	20	$11\ 9/64$ "	$4\ 49/64$ "	$1\ 21/32$ "	$15/16$ "	$25/32$ "

¹ S_k = Actual dimension of the test attachment; l_k = Distance from the force application point to the test device axis



400 Hex Torque-indicator

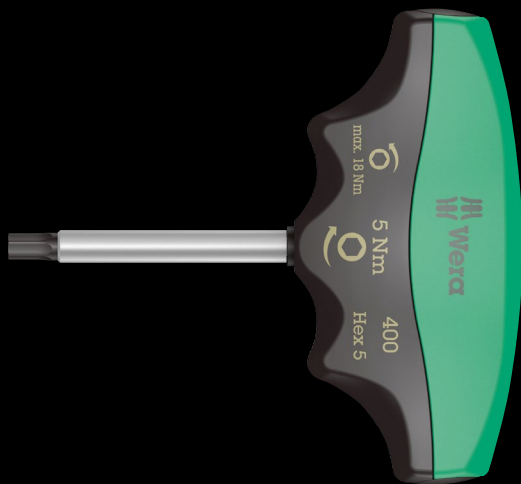

Application: Hexagon socket screws

Pre-set torque: 4,0 Nm, 5,0 Nm; fixed pre-set

Accuracy: ±10 %. Reliable slipping mechanism and acoustic signal when reaching the set torque.

Blade: Round

Design: Hex-Plus, brushed chrome-plated finish, Black Point

Handle: T-handle, multi-component

	⊙	Nm	⌢ mm	⌢ mm	⌢ mm	⌢ mm	∅ mm
05005080001	4,0	4,0	60	48	100	2 3/8"	7,0
05005081001	5,0	5,0	60	48	100	2 3/8"	7,0

Excess-load signal

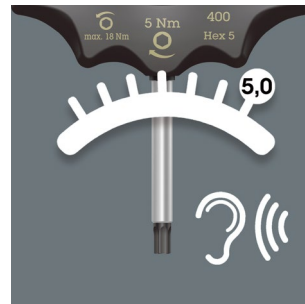

Distinctly audible and noticeable excess-load signal when the pre-set torque is reached.

Ergonomic design

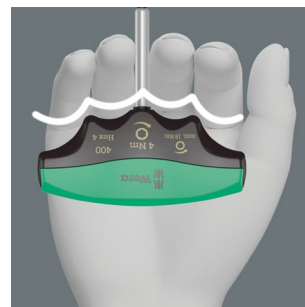

The ergonomic design of the T-handle fills the palm of the hand. The fingers rest in the soft, rounded recess, and the whole hand is in contact with the handle – so there is no friction loss between the hand and handle.

Multi-component handle



Multi-component screwdriver handle for ergonomic working.

950/9 Hex-Plus 1 L-key set, metric, chrome-plated



9-piece set in a two-component clip

Application: Hexagon socket screws

Design: Chrome-plated

Tip: Hex-Plus, ball-end hexagon on long arm

05022087001		
○	950 PKL	1x 1,5x90 ¹⁾ ; 1x 2,0x100; 1x 2,5x112; 1x 3,0x126; 1x 4,0x140; 1x 5,0x160; 1x 6,0x180; 1x 8,0x200; 1x 10,0x219

¹⁾ Regular hexagon

950/9 Hex-Plus 6 L-key set, metric, BlackLaser



9-piece set in a two-component clip

Application: Hexagon socket screws

Design: BlackLaser surface

Tip: Hex-Plus, ball-end hexagon on long arm

05022086001		
○	950 PKL BM	1x 1,5x90 ¹⁾ ; 1x 2,0x100; 1x 2,5x112; 1x 3,0x126; 1x 4,0x140; 1x 5,0x160; 1x 6,0x180; 1x 8,0x200; 1x 10,0x219

¹⁾ Regular hexagon

950/9 Hex-Plus 3 L-key set, metric, chrome-plated



9-piece set in a two-component clip

Application: Hexagon socket screws

Design: Chrome-plated

Tip: Hex-Plus, ball-end hexagon on long arm

05133163001		
○	950 PKS	1x 1,5x50 ¹⁾ ; 1x 2,0x56; 1x 2,5x63; 1x 3,0x71; 1x 4,0x80; 1x 5,0x90; 1x 6,0x100; 1x 8,0x112; 1x 10,0x125

¹⁾ Regular hexagon

950/9 Hex-Plus 4 L-key set, metric, chrome-plated



9-piece set in a two-component clip

Application: Hexagon socket screws

Blade: Chrome plated, with extra short arm for use on screws that are difficult to access

Tip: Hex-Plus, ballpoint hexagon on long arm

05073594001		
○	950 PKLS	1x 1,5x90 ¹⁾ ; 1x 2,0x100; 1x 2,5x112; 1x 3,0x126; 1x 4,0x140; 1x 5,0x160; 1x 6,0x180; 1x 8,0x200; 1x 10,0x219

¹⁾ Regular hexagon



Hex-Plus



Hexagon screws can endure a problem because the contact surfaces delivering the power from the conventional tool, is transferred to the screw via very small surface areas. The consequence: the screw can become damaged (rounding out). Hex-Plus tools have a greater contact surface that

prevents this from happening! At the same time, as much as 20 % more torque can be applied. Good to know: Hex-Plus tools fit into every standard hexagon socket screw!



With extra short arm

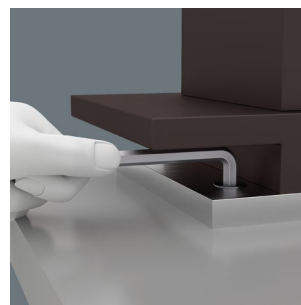

All users will recognise the need to saw or grind down L-keys to make them shorter for particularly confined screwdriving jobs. This has the disadvantage that they no longer have any corrosion protection at the separation point and secondly, they can become "soft" and therefore useless due to an alteration in the hardening during the shortening process.

950/9 Hex-Plus 8 L-key set, metric, chrome-plated



9-piece set, in a rack that can be set upright on the table or hung on the wall thanks to the 9109 wall holder/base; integrated removable clip 9536 for mobile use, integrated removable magnet 9538 for magnetising and demagnetising tool tips

Application: Hexagonal socket screws

Design: Chrome-plated

Tip: Hex-Plus, hexagonal ball tip at the long arm

05022102001	
○	950 PKL 1x 1,5x90 ¹⁾ ; 1x 2,0x100; 1x 2,5x112; 1x 3,0x126; 1x 4,0x140; 1x 5,0x160; 1x 6,0x180; 1x 8,0x200; 1x 10,0x219
	9109
	9536
	9538

¹⁾ Regular hexagon

Clip for take-away

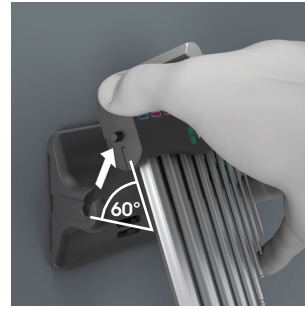

The rack for the L-keys can be set up on the table or hung on the wall. The clip is removable; so the L-keys can also be taken out and about.



Removable magnetiser

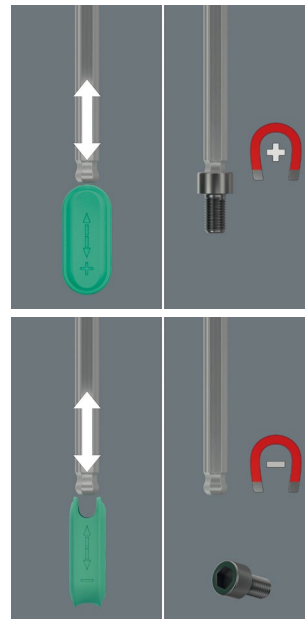

The rack includes a removable magnetiser that can be used to magnetise (and demagnetise) screws and tool tips.

950/9 Hex-Plus Multicolour 2 L-key set, metric, BlackLaser



9-piece set in a two-component clip

Application: Hexagon socket screws

Design: BlackLaser surface, durable plastic sleeve. The contrasting inscriptions on the colour-coded sleeves mean that it is easy to recognise the correct sizes and this makes it simpler to find the right tool.

Tip: Hex-Plus, ball-end hexagon on long arm

05133164001	
○	950 SPKS Multicolour 1x 1,5x50; 1x 2,0x56; 1x 2,5x63; 1x 3,0x71; 1x 4,0x80; 1x 5,0x90; 1x 6,0x100; 1x 8,0x112; 1x 10,0x125

950/9 Hex-Plus Multicolour 3 L-key set, metric, BlackLaser

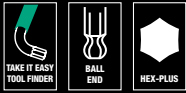

9-piece set, in a rack that can be set upright on the table or hung on the wall thanks to the 9109 wall holder/base; integrated removable clip 9539 for mobile use, integrated removable magnet 9538 for magnetising and demagnetising tool tips

Application: Hexagonal socket screws

Design: BlackLaser surface, with hose sleeve. All L-keys are easily accessible due to their colour coding and size markings.

Tip: Hex-Plus, hexagonal ball tip at the long arm

05133165001	
950 SPKL Multicolour	1x 1,5x90; 1x 2,0x101; 1x 2,5x112; 1x 3,0x123; 1x 4,0x137; 1x 5,0x154; 1x 6,0x172; 1x 8,0x195; 1x 10,0x224
9539	
9109	
9538	

950/9 Hex-Plus Multicolour HF 1 L-key set, metric, BlackLaser, with holding function



9-piece set in a two-component clip

Application: Hexagon socket screws

Design: BlackLaser surface, durable plastic sleeve. The contrasting inscriptions on the colour-coded sleeves mean that it is easy to recognise the correct sizes and this makes it simpler to find the right tool.

Tip: Hex-Plus, ball-end hexagon on long arm, holding function for hexagon socket screws, sizes: 1,5, 2,0 and 2,5 without holding function

05022210001	
950 SPKL Multicolour	1x 1,5x90; 1x 2,0x101; 1x 2,5x112
950 SPKL HF Multicolour	1x 3,0x123; 1x 4,0x137; 1x 5,0x154; 1x 6,0x172; 1x 8,0x195; 1x 10,0x224

Clip for take-away



The rack for the L-keys can be set up on the table or hung on the wall. The clip is removable; so the L-keys can also be taken out and about.



Removable magnetiser

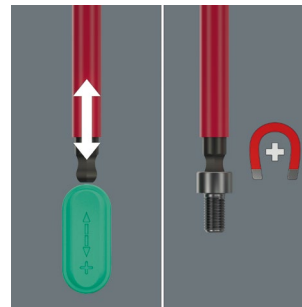

The rack includes a removable magnetiser that can be used to magnetise (and demagnetise) screws and tool tips.

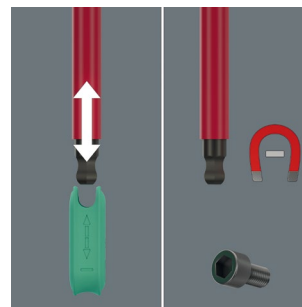

967 SPKL/9 TORX® BO SB Multicolour L-key set for tamper-proof TORX® screws, BlackLaser



9-piece set in a two-component clip. For recessed screws, it's often advantageous for the screw to be held on the L-key by magnetic force. The Wera clips with magnetiser/demagnetiser enable a magnetisation/demagnetisation of L-keys in a flash.

Application: TORX® socket screws with and without pin (BO = bore hole)

Design: BlackLaser, durable plastic sleeve. The contrasting inscriptions on the colour-coded sleeves mean that it is easy to recognise the correct sizes and this makes it simpler to find the right tool.

Tip: TORX® on short arm, TORX® ball end on long arm

05073599001	
967 SPKL TORX® BO Multicolour	1x TX 8x76 ¹⁾ ; 1x TX 9x79 ¹⁾ ; 1x TX 10x85 ²⁾ ; 1x TX 15x90; 1x TX 20x96; 1x TX 25x104; 1x TX 27x112; 1x TX 30x122; 1x TX 40x132

¹⁾ Product without bore hole at the short and without ball-end at the long arm.

²⁾ Product without ball-end at the long arm.



L-keys with retaining function for hexagon socket screws



The clamping of the screw is achieved by a flexible locking ball. The holding function is especially helpful in confined, hard-to-reach spaces, where there is no room for a second hand to secure the screw on the tool.

967/9 TX HF 1 L-key set with holding function, BlackLaser



9-piece set in a two-component clip

Application: TORX® socket screws

Design: Round

Tip: TORX® on short arm, holding function for TORX® screws made according to Acument Intellectual Properties specifications on long arm, BlackLaser surface

05024244001	
♻️	967 L TORX® HF 1x TX 8x76; 1x TX 9x79; 1x TX 10x85; 1x TX 15x90; 1x TX 20x96; 1x TX 25x104; 1x TX 27x112; 1x TX 30x122; 1x TX 40x132

967/9 TX Multicolour HF 1 L-key set with holding function



9-piece set in a two-component clip

Application: TORX® socket screws

Design: Round, zinc-phosphated, durable plastic sleeve. The contrasting inscriptions on the colour-coded sleeves mean that it is easy to recognise the correct sizes and this makes it simpler to find the right tool.

Tip: TORX® on short arm, holding function for TORX® screws made according to Acument Intellectual Properties specifications on long arm

05024179001	
♻️	967 SL TORX® HF 1x TX 8x76; 1x TX 9x79; 1x TX 10x85; 1x TX 15x90; 1x TX 20x96; 1x TX 25x104; 1x TX 27x112; 1x TX 30x122; 1x TX 40x132

967/9 TX XL Multicolour 1 L-key set for TORX® screws, long



9-piece set in a two-component clip

Application: TORX® socket screws

Design: Round, zinc-phosphated, durable plastic sleeve. The contrasting inscriptions on the colour-coded sleeves mean that it is easy to recognise the correct sizes and this makes it simpler to find the right tool.

Tip: TORX® on short arm, TORX® ball end on long arm, TX 8, TX 9, TX 10: without ball-end at the long arm

05024480001	
♻️	967 SXL TORX® Multi-colour 1x TX 8x90; 1x TX 9x101; 1x TX 10x112
♻️	967 SPKXL TORX® Multi-colour 1x TX 15x123; 1x TX 20x137; 1x TX 25x154; 1x TX 27x172; 1x TX 30x195; 1x TX 40x224

967/9 TX XL Multicolour HF 1 L-key set with holding function, long



9-piece set in a two-component clip

Application: TORX® socket screws

Design: Zinc-phosphated, durable plastic sleeve. The contrasting inscriptions on the colour-coded sleeves mean that it is easy to recognise the correct sizes and this makes it simpler to find the right tool.

Tip: TORX® on short arm, holding function for TORX® screws made according to Acument Intellectual Properties specifications on long arm

05024470001	
♻️	967 SXL HF TORX® Multi-colour 1x TX 8x90; 1x TX 9x101; 1x TX 10x112; 1x TX 15x123; 1x TX 20x137; 1x TX 25x154; 1x TX 27x172; 1x TX 30x195; 1x TX 40x224



454 HF T-handle hexagon screwdriver Hex-Plus with holding function



Application: Hexagon socket screws

Blade: Hexagon

Design: With long and short arm, Hex-Plus, bevelled, matte chrome-plated, with holding function for hexagon socket screws on the long arm

Handle: T-shape, 2 components, with hole for hanging. With Take it Easy Tool Finder: Colour coding by profiles (blue = hexagon socket) and size stamping.

454 T-handle hexagon screwdriver Hex-Plus

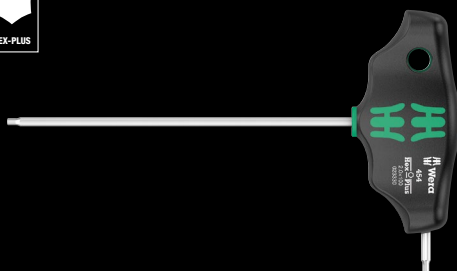

Application: Hexagon socket screws

Blade: Round

Design: With long and short arm, Hex-Plus, bevelled, matte chrome-plated

Handle: T-shape, 2 components, with hole for hanging. With Take it Easy Tool Finder: Colour coding by profiles (blue = hexagon socket) and size stamping.

	mm	mm	mm	mm	mm	mm
05023330001	2	100	12	32	65	4"
05023332001	2,5	100	12	32	65	4"

	mm	mm	mm	mm	mm	mm
05023334001	3	100	15	38	77	4"
05023338001	4	100	15	38	77	4"
05023339001	4	150	15	38	77	6"
05023340001	4	200	15	38	77	8"
05023342001	5	100	20	49	99	4"
05023343001	5	150	20	49	99	6"
05023344001	5	200	20	49	99	8"
05023346001	6	100	20	49	99	4"
05023347001	6	150	20	49	99	6"
05023348001	6	200	20	49	99	8"
05023350001	7	200	20	49	99	8"
05023351001	8	100	20	49	99	4"
05023352001	8	150	20	49	99	6"
05023353001	8	200	20	49	99	8"
05023354001	10	100	20	49	99	4"
05023355001	10	200	20	49	99	8"

454/7 HF Set 1 screwdriver set T-handle screwdrivers Hex-Plus with holding function

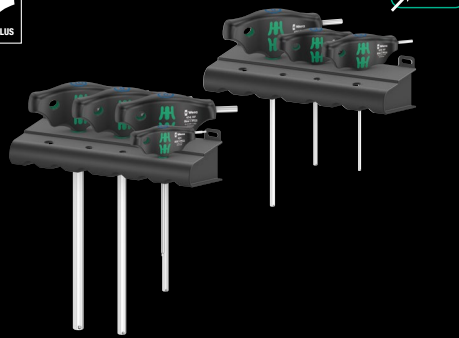

wera.de

Application: Hexagon socket screws, with holding function on the long arm from size 3

Design: With Take it Easy Tool Finder: colour coding according to profile (blue = hexagon socket) and size stamp. 7-piece set and 2 racks in display carton

05023450001		
○	454	1x 2,5x100
○	454 HF	1x 3x100; 1x 4x100; 1x 5x150; 1x 6x150; 1x 8x200; 1x 10x200
	Rack for Kraftform screwdrivers	2x 190,0x50,0

467/7 TORX® HF Set 1 screwdriver set T-handle TORX® screwdrivers with holding function

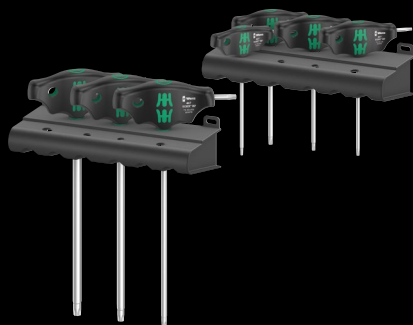

wera.de

Application: TORX®, with holding function on the long arm for TORX® screws as per specification "Acument Intellectual Properties"

Design: With Take it Easy Tool Finder: colour coding according to profile (green = TORX®) and size stamping. 7-piece set and 2 racks in display carton

05023452001		
♻️	467 TORX® HF	1x TX 10x100; 1x TX 15x100; 1x TX 20x100; 1x TX 25x100; 1x TX 30x200; 1x TX 40x200; 1x TX 45x200
	Rack for Kraftform screwdrivers	2x 190,0x50,0

Second arm



The additional short arm, which emerges laterally from the handle, allows the transmission of extremely high torques by using the long arm as a lever.

High torque transfer

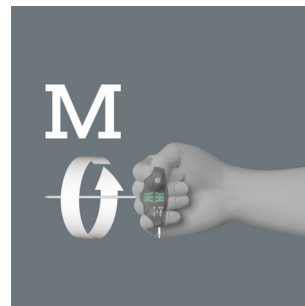

By using the blade as an extension of your lower arm you can transfer particularly high torque.

With useful plastic racks

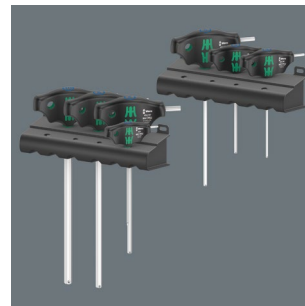

Including useful racks for well-arranged storage of the screwdrivers.



Holding function (HF) for hexagon socket screws



A resilient ball ensures the hexagon socket screw to be clamped on the tool tip. Especially helpful in hard to reach areas where you can not use your other hand to hold the screw.





Holding function



The Joker's holding function means that nuts and bolts can be held in the jaw and easily positioned where they are needed. Fastening on to the thread can then be done quickly and safely, thanks to the innovative special stop-plate which holds the fastener. No more time-wasting searches

for dropped nuts and bolts! After applying and positioning the nut or bolt, fastening can begin immediately – no additional tools required.



Integrated limit-stop

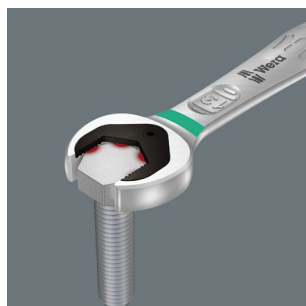

Constant re-positioning of the wrench? Difficulty holding fasteners in confined spaces? Easing off to avoid any risks of injury or fastener damage? That was yesterday. Today, the Joker prevents slipping off of the fastener head with its integrated limit-stop – no longer is the thumb needed to act as a depth

stop. This makes applications much easier and allows significantly more force to be applied during fastening jobs.

Double-hex geometry



The Joker's clever double-hex geometry delivers a very positive connection with nuts or bolts – it's a perfect fit. And the exchangeable, hardened metal gripping plate in the Joker's open end literally bites itself into the bolt, with its extremely hard tips. Both features combine to prevent slipping, even at higher torque.



Small return angle



Instead of 60°, the Joker only has a 30° return angle thanks to its unique double-hex design. Along with the Joker's straight neck, this means that flipping the wrench has become a thing of the past. With the Joker, you can now loosen and tighten nuts and bolts, in situations where conventional tools fail. Particu-

larly in confined spaces, where conventional open-jawed wrenches cannot be used. The combination of limit stop and small return angle enables effective work, even on screw pipe connections.

9630 Magnetic rail 6000 Joker 1 Ring ratchet spanner set



Ring ratchet spanner set, metric sizes

11-piece set

On a magnetic rail

Part No.	Description	Quantity
05020014001	6000 Joker	1x 8x144; 1x 10x159; 1x 11x165; 1x 12x170,7; 1x 13x177; 1x 14x188; 1x 15x200; 1x 16x212; 1x 17x224; 1x 18x235; 1x 19x246
9610	1x 30,0x370,0	

6000 Joker Ratcheting combination wrenches

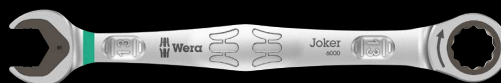

Application: Hexagonal nuts or bolts

Design: Ratcheting combination wrench

Part No.	Wrench Size	Wrench Length	Wrench Width	Wrench Thickness	Wrench Height	Wrench Depth
	mm	mm	mm	mm	mm	mm
05073268001	8	144	20	5,5	18	7
05073270001	10	159	22	5,5	21	7,2
05073271001	11	165	25	6,3	22	7,5
05073272001	12	170,7	26,3	6,6	25	8,5
05073273001	13	177	27,3	7	25	8,6
05073274001	14	188	29,3	7,5	28	9,2
05073275001	15	200	32,3	7,8	28,5	9,2
05073276001	16	212	35	8,2	32,7	10,5
05073277001	17	224	37,2	8,5	32,7	10,5
05073278001	18	235	39	9	33,8	11
05073279001	19	246	42	9,5	34,8	11



Joker 6003: For very tight spaces



The Joker 6003 combination wrench with its special mouth geometry – an open-end offset by 7.5° and the double hexagon profile – doubles the placement possibilities when repeatedly turning the wrench 180° around the longitudinal axis. Bolts and screw heads can be "accessed" every 15°.

Joker 6003 will automatically find the respective placement point after every turn.

For return angles under 30°



Thanks to the open end side offset by 7.5°, double hexagon geometry and an adjusted application method (placement – screwdriving – turning – replacement – screwdriving – turning, etc), even screwdriving challenges allowing a return angle of less than 30° can be solved.

Double-hex geometry

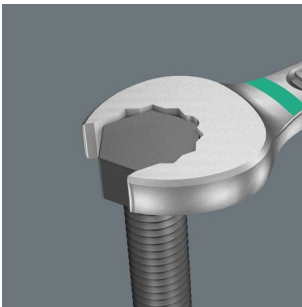

The double hexagon geometry on the open end and ring sides secures the positive connection with the screw head or bolt and reduces the risk of slipping.



6003 Joker Pedal



The extra thin pedal ring spanner (6003 Joker 15 Pedal) is ideal for narrow installation spaces.

9640 Magnetic rail 6003 Joker 1 Ring spanner set

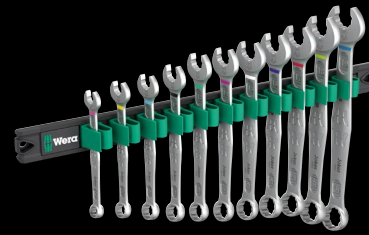

Ring spanner set, metric sizes, open end side offset by 7.5°

11-piece set

On a terminal strip

05020233001	6003 Joker	1x 8x115; 1x 10x125; 1x 11x135; 1x 12x148; 1x 13x160; 1x 14x167; 1x 15x174; 1x 16x182; 1x 17x190; 1x 18x210; 1x 19x230,0
9610		1x 30,0x370,0

6003 Joker combination wrench



Application: Hexagon screw heads and bolts

Design: Combination wrench; open-end offset by 7.5°, ring side pivoted by 15°; with Take it Easy Tool Finder: colour coding by size

	mm	mm	mm	mm	mm	mm
05020190001	5,5	105	16	4	10	6
05020198001	6	105	16	4	10	6
05020199001	7	110	17,7	4,2	11,5	6
05020200001	8	115	19	4,5	12,5	7
05020219001	9	120	21	4,8	13,5	7
05020201001	10	125	22	5	15	7
05020202001	11	135	24,5	5	17	8
05020203001	12	148	26	5,5	18	8,5
05020204001	13	160	27	6	19	8,5
05020205001	14	167	29	6	20	8,5
05020206001	15	174	32	6	22	8,5
05020207001	16	182	35	6,5	23	10
05020208001	17	190	38	6,5	24,5	10
05020209001	18	210	39	7,5	26	11,5
05020210001	19	230	42	7,5	27,5	11,5
05020500001	20	230	45	7,5	29	13
05020501001	21	260	47	7,5	30	13
05020502001	22	260	49	7,5	31,5	13
05020503001	24	280	53	8	36	14
05020504001	27	300	60	8,5	40	14,5
05020505001	30	330	66	9	43	16
05020506001	32	360	70	9,5	45,5	16,5
05020507001	36	460	80	10	50,5	18

6003 Joker Pedal combination wrench



Application: Hexagon bolts and screw heads

Design: Ring spanner, extra-flat open end side; open end side offset by 7.5°; ring side pivoted by 15°; with Take it Easy Tool Finder; colour coding by size

	mm	mm	mm	mm	mm	mm
05020221001	15	174	32	4,5	22	8,5

6004 Joker 4 set 1 self-setting spanner set



Self-setting spanner set
4-piece set
In robust folding pouch

05020110001					
	6004 Joker XS	1x 7-10x ¹ / ₄ "- ³ / ₈ "x117			
	6004 Joker S	1x 10-13x ⁷ / ₁₆ "- ¹ / ₂ "x154			
	6004 Joker M	1x 13-16x ¹ / ₂ "- ⁵ / ₈ "x188			
	6004 Joker L	1x 16-19x ⁵ / ₈ "- ³ / ₄ "x224			

6004 Joker M self-setting spanner



Application: Hexagon screw heads and bolts with wrench size 13-16 (metric) or 1/2" - 5/8" (imperial)

Design: Self-setting spanner with ratchet feature; size-adjustable open end side, parallel smooth jaws, with 30° return angle due to the corner-width rectangular prisms in the jaws; hole for hanging

	mm	mm	mm	mm
05020103001	13-16	1/2"-5/8"	188	12,4

6004 Joker S self-setting spanner



Application: Hexagon screw heads and bolts with wrench size 10-13 (metric) or 7/16" - 1/2" (imperial)

Design: Self-setting spanner with ratchet function; size-adjustable open end side, parallel smooth jaws; with 30° return angle due to the corner-width rectangular prisms in the jaws; hole for hanging

	mm	mm	mm	mm
05020100001	10-13	7/16"-1/2"	154	10



Joker 6004: Automatically and continuously self-setting

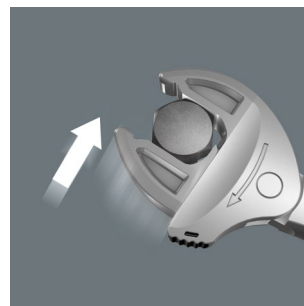

With its automatically and continuously gripping parallel jaws the Joker spanner 6004 covers all dimensions in the respective field of application. The tool automatically finds the required size when placed on the bolt or screw, no setting required.



Joker 6004: Ratchet mechanism for fast work



The ratchet function in the open end sees to fast and consistent screwdriving without removing the tool.

8000 A Zyklop Speed Ratchet with 1/4" drive



Application: 1/4" square sockets and 1/4" adaptors with square drive, equipped with ball lock

Design: Flywheel design and easy-to-grip free-turning sleeve for faster work, swivel ratchet head, defined lock positions at 0° and 90° to the left and right as well as at 15° before 90° inwards, at 0° it can be used like a conventional screwdriver, pushbutton release, left/right switchover, fine-tooth design, small return angle of 5°

Handle: Multi-component Kraftform handle ensures minimum fatigue

	8, mm
05003500001	1/4" 152,0

8100 SA 6 Zyklop Speed Ratchet Set, 1/4" drive, metric



28-piece set; in a surface-preserving, compact and extremely robust textile box; low volume and weight for simplified mobility

1 Zyklop Speed Ratchet with 1/4" drive, 9 Zyklop sockets, 1 Zyklop extension (long) with free-turning sleeve, 1 wobble extension, 1 adaptor with quick-release chuck, 15 bits

05004016001	
	8000 A 1x 1/4"x152,0
	8790 HMA 1x 5,0x23,0; 1x 5,5x23,0; 1x 6,0x23,0; 1x 7,0x23,0; 1x 8,0x23,0; 1x 10,0x23,0; 1x 11,0x23,0; 1x 12,0x23,0; 1x 13,0x23,0
	8794 LA 1x 1/4"x150,0
	8794 A 1x 1/4"x56,0
	8784 A1 1x 1/4"x1/4"x37,0
	851/4 TZ 1x PH 1x50; 1x PH 2x50; 1x PH 3x50
	855/4 TZ 1x PZ 1x50; 1x PZ 2x50
	867/4 Z TORX® 1x TX 10x50; 1x TX 15x50; 1x TX 20x50; 1x TX 25x50; 1x TX 27x50; 1x TX 30x50
	840/4 Z 1x 3,0x50; 1x 4,0x50; 1x 5,0x50; 1x 6,0x50 ¹⁾
	Hook and Loop Fastener Strip 120

¹⁾ Hexagonal blade



The Zyklop Speed ratchet

Pivots freely



The ratchet head pivots freely and can be locked into any defined position by using the slide switch that is positioned on either side. It is even possible to work in very confined and difficult-to-access areas with enhanced hand clearance. The predefined locking at 0°, 15° and 90°, both to the right and left, ensure safe working without any slipping of the ratchet head.



Fast movers



The Zyklop Speed ratchets are really fast movers. The gyrating mass design means that screw-driving is accelerated. The rotation-symmetric structure of the Kraftform handle and the free-turning sleeve reinforce this rapid twisting process, particularly when the ratchet does not engage due to too little resistance in the thread.

Textile boxes



The textile boxes offer dramatically improved portability, and are space-saving to boot! This means you can now carry the same collection of tools, in a much more compact and comfortable package. The hassle of running back and forth for the right tools has now become a thing of the past.

And the much lower weight of a set makes carrying more convenient than ever before. The textile box including the tool will even survive a fall undamaged.

8009 Zyklop Pocket Set 1



wera.de



13-piece set; 1 Zyklop Pocket 8009 for $\frac{3}{8}$ " sockets as well as $\frac{3}{8}$ " connectors with square head drive; also suitable for bits with $\frac{1}{4}$ " external hexagon drive as per DIN ISO 1173-C 6.3 and E 6.3 and Wera connection series 1 and 4. $\frac{3}{8}$ " ratchet and $\frac{1}{4}$ " bit ratchet screwdriver; freely swivelling ratchet head; pre-defined positions at 0°, 15° and 90° to the left and right; can be used as a conventional screwdriver in the 0° position; clockwise/counterclockwise switching, fine-toothed, small return angle of 5°; magnetic direct mounting. Multi-component Kraftform handle for fatigue-free working; captive, freely swivelling magazine with 12 bits integrated in the handle, $\frac{1}{4}$ ", 25 mm length.

05004280001	
● ○	8009 1x $\frac{3}{8}$ "x $\frac{1}{4}$ "x133,0
+	851/1 BTZ 1x PH 1x25; 1x PH 2x25
+	855/1 BTZ 1x PZ 1x25; 1x PZ 2x25
⊕	867/1 TORX® BTZ 1x TX 10x25; 1x TX 15x25; 1x TX 20x25; 1x TX 25x25
○	840/1 BTZ 1x 3,0x25; 1x 4,0x25; 1x 5,0x25; 1x 6,0x25



Combination tool mounting

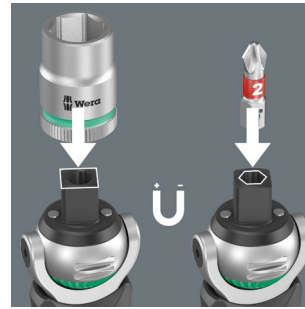

The magnetic direct mounting is suitable for $\frac{3}{8}$ " sockets as well as $\frac{1}{4}$ " bits without the need for an adapter.

With integrated bit magazine

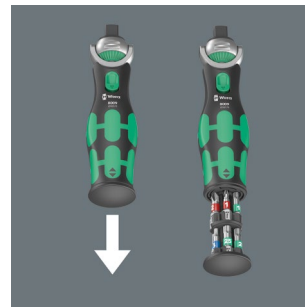

A captive, freely swivelling bit magazine for 12 bits ($\frac{1}{4}$ ", 25 mm length) is integrated in the handle of the compact Zyklop ratchet.

Kraftform Kompakt 27 XL Universal 1



wera.de



Application: Suitable for bits with $\frac{1}{4}$ " external hexagon drive as per DIN ISO 1173-C 6.3 and E 6.3 and Wera connection series 1 and 4

Design: 300 mm long rigid blade; with compact stainless steel holder and strong permanent magnet. Secure bit holding function thanks to locking mechanism.

Handle: Kraftform with anti-roll protection, multi-component, integrated bit magazine

05051028001	
+	851/1 BTZ 1x PH 1x25; 1x PH 2x25
+	855/1 BTZ 1x PZ 1x25
⊕	867/1 TORX® BTZ 1x TX 15x25; 1x TX 20x25; 1x TX 25x25
●	394 S 1x $\frac{1}{4}$ "x300

300 mm long blade

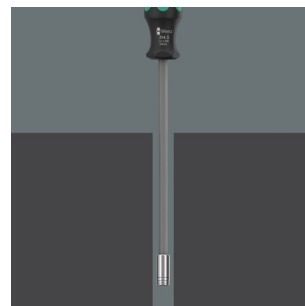

The 300 mm long blade makes it possible to reach even low lying couplings

Secure hold and easy removal



Secure bit holding feature due to locking mechanism. With strong permanent magnet.

Bitholding screwdrivers with ratchet functionality



Ratchet functionality



The integrated ratchet with fine tooththing (36 teeth) and a return angle of 10° eases and accelerates screwdriving without having to reposition the tool.



Rapid screwdriving



The ratchet mechanism also allows fast "spinning" while screwdriving.



Changing ratchet direction



Ergonomic design of the reverse direction switch.



Chuck-all

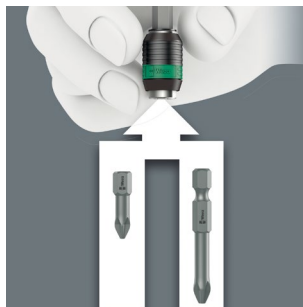

The Rapidaptor quick-release chucks hold 1/4" DIN ISO 1173-C 6,3 and E 6,3 as well as Wera series 1 and 4 bits.

838 RA-R M Bitholding screwdriver with ratchet functionality, 1/4"



Application: Suitable for bits with 1/4" external hexagon drive as per DIN ISO 1173-C 6.3 and E 6.3 and Wera connection series 1 and 4

Design: Ratchet with fine tooththing integrated in the handle (36 teeth, return angle 10°); 1/4" hexagonal socket mounting for bits with 1/4" external hexagon drive as per DIN ISO 1173-C 6.3 and E 6.3 and Wera connection series 1 and 4, magnetic

Handle: Kraftform with anti-roll protection, multi-component

		mm	mm
05051493001	1/4"	123,5	98

838 RA S Bitholding screwdriver with ratchet function, 1/4"



Application: Suitable for bits with 1/4" external hexagon drive

Design: Ratchet with fine tooththing integrated in the handle (36 teeth, return angle 10°); 1/4" hexagonal socket mounting for bits with 1/4" external hexagon drive, magnetic

Handle: Kraftform with anti-roll protection, multi-component

		mm	mm
05051492001	1/4"	102	93,5



Take it Easy Tool Finder

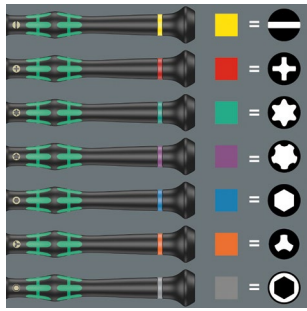

Screwdrivers with Take it Easy Tool Finder: colour coding according to profile and size stamp.

Kraftform Micro 12 Universal 1 screwdriver set



Take it Easy Tool Finder: colour coding according to profile and size stamp.

Application: Slotted, Phillips, TORX® and hexagon socket screws

Content: 12-piece set, in a belt pouch

05073675001	
+	2050 Micro 1x PH 00x60 ¹⁾ ; 1x PH 0x60 ²⁾
⊕	2067 TORX® HF Micro 1x TX 5x40; 1x TX 6x40
⊖	2035 Micro 1x 0,23x1,5x40; 1x 0,30x1,8x60; 1x 0,40x2,0x60; 1x 0,40x2,5x80; 1x 0,50x3,0x80
○	2054 Micro 1x 0,9x40; 1x 1,5x60; 1x 2x60
	Hook and Loop Fastener Strip 70 1x 50,0x70,0

¹⁾ Optimised for Asian PH screws

²⁾ Size 0 modified according to JClS 0 (Japanese Camera Industrial Standard)

Kraftform Kompakt 20 Tool Finder 2 with pouch



Application: Suitable for 1/4" DIN ISO 1173-C 6.3 and E 6.3 hexagon socket insert bits and Wera Series 1 and 4

Design: Attachment, telescopic, Rapidaptor rapid-in, rapid-out, rapid-spin, chuck-all and single-hand technology; "Take it easy" tool finder: Output colour coding and large stamp to enable the desired bit to be easily located.

Handle: Kraftform with non-roll feature, multi-component, integrated magazine

05051017001	
⊕	889/4 R 1x 1/4"x100
+	851/1 BTZ 1x PH 1x25; 1x PH 2x25
⊕	855/1 BTZ 1x PZ 1x25; 1x PZ 2x25
⊕	867/1 TORX® BTZ 1x TX 20x25; 1x TX 25x25
+	851/4 Z 1x PH 1x89; 1x PH 2x89
⊕	855/4 Z 1x PZ 1x89; 1x PZ 2x89
⊕	867/4 Z TORX® 1x TX 20x89; 1x TX 25x89
	Hook and Loop Fastener Strip 70 1x 50,0x70,0

Telescopic blade, integrated bit magazine, Rapidaptor technology



The sets in the series Kraftform Kompakt 20 are really something. A 2 position telescopic blade can be retracted into the handle for confined space operation or extended for more reach. It can also be removed and used as a 100mm bit holder in the power tool. Six bits are conveniently integrated into a

push-button opening bit magazine. The Rapidaptor technology ensures rapid one hand bit changes, press-in auto bit lock and a secure positioning when used in power tools thanks to the free-turning sleeve.

Handle/interchangeable blade system



The handle/interchangeable blade system allows rapid exchange of the blades required for a wide range of applications.



Ratchet function

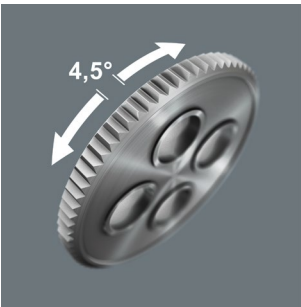

The integrated ratchet with fine toothing (80 teeth) and a return angle of 4.5° eases and accelerates screwdriving without having to reposition the tool.

Ratchet mechanism in the handle

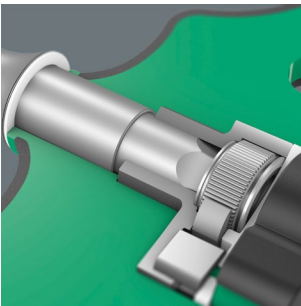

The ratchet mechanism of the 416 RA T-handle bitholding screwdriver is completely embedded in the handle. The compact shape of the tool allows convenient working.

Reversible clockwise/counterclockwise

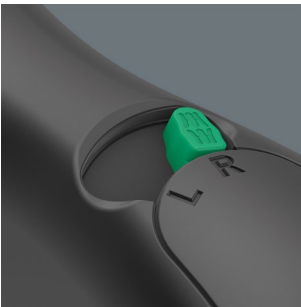

The change of direction can easily be made using the reversing lever.

Fast-rotating sleeve

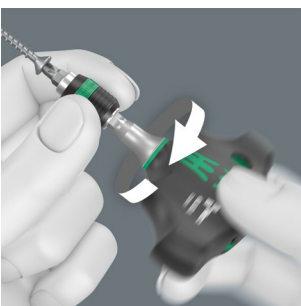

The fast-rotating sleeve allows the tool to be guided safely while screwdriving and increases the working speed.

Kraftform Kompakt 400 RA Set 1



17-piece set

Textile box with one 416 RA T-handle bitholding screwdriver with ratchet function and Rapidaptor quick-release chuck, 16 tough bits, 1/4", 89 mm length

05023471001	
⊙	416 RA 1x 1/4"x45
+	851/4 Z 1x PH 2x89; 1x PH 3x89 ¹⁾
+	855/4 Z 1x PZ 2x89; 1x PZ 3x89 ¹⁾
⊗	867/4 Z TORX® 1x TX 10x89; 1x TX 15x89; 1x TX 20x89; 1x TX 25x89; 1x TX 30x89; 1x TX 40x89
○	840/4 Z 1x 3,0x89; 1x 4,0x89; 1x 5,0x89; 1x 6,0x89 ¹⁾ ; 1x 8,0x89 ¹⁾
⊖	800/4 Z 1x 1,0x5,5x89
	Hook and Loop Fastener Strip 120

¹⁾ Hexagonal blade

Kraftform Kompakt 400

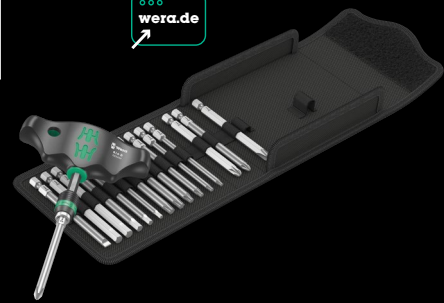

Folding pouch with 89 mm long bits

17-piece set

1 bit handholder 416 R T-handle with Rapidaptor quick-release chuck

05057470001	
⊙	416 R 1x 1/4"x45
+	851/4 Z 1x PH 2x89; 1x PH 3x89 ¹⁾
+	855/4 Z 1x PZ 2x89; 1x PZ 3x89 ¹⁾
⊗	867/4 Z TORX® 1x TX 10x89; 1x TX 15x89; 1x TX 20x89; 1x TX 25x89; 1x TX 30x89; 1x TX 40x89
○	840/4 Z 1x 3,0x89; 1x 4,0x89; 1x 5,0x89; 1x 6,0x89 ¹⁾ ; 1x 8,0x89 ¹⁾
⊖	800/4 Z 1x 1,0x5,5x89
	Hook and Loop Fastener Strip 120

¹⁾ Hexagonal blade

Kraftform Kompakt Turbo 1

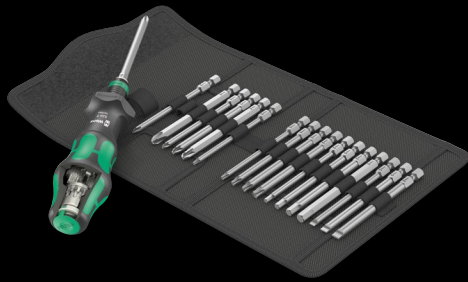

Folding pouch with 89 mm long bits

19-piece set

1 bit-holding Kraftform Turbo with Rapidaptor quick-release chuck

05057482001	
●	826 T Kraftform Turbo 1x 1/4"x146
+	851/4 Z 1x PH 1x89; 1x PH 2x89; 1x PH 3x89 ¹⁾
+	855/4 Z 1x PZ 1x89; 1x PZ 2x89; 1x PZ 3x89 ¹⁾
⊗	867/4 Z TORX® 1x TX 10x89; 1x TX 15x89; 1x TX 20x89; 1x TX 25x89; 1x TX 30x89
○	840/4 Z 1x 3,0x89; 1x 4,0x89; 1x 5,0x89; 1x 6,0x89 ¹⁾
◐	800/4 Z 1x 0,8x4,0x89; 1x 1,0x5,5x89; 1x 1,2x6,5x89
	Hook and Loop Fastener Strip 120 1x 50,0x120,0

¹⁾ Hexagonal blade

Kraftform Kompakt 60



Pouch with 89 mm bits

17-piece set

1 Kraftform bitholding screwdriver 816 R with Rapidaptor quick-release chuck

05059295001	
●	816 R 1x 1/4"x119
+	851/4 Z 1x PH 1x89; 1x PH 2x89; 1x PH 3x89 ¹⁾
+	855/4 Z 1x PZ 1x89; 1x PZ 2x89; 1x PZ 3x89 ¹⁾
⊗	867/4 Z TORX® 1x TX 10x89; 1x TX 15x89; 1x TX 20x89; 1x TX 25x89; 1x TX 30x89
◐	800/4 Z 1x 1,0x5,5x89
○	840/4 Z 1x 3,0x89; 1x 4,0x89; 1x 5,0x89; 1x 6,0x89 ¹⁾
	Hook and Loop Fastener Strip 70 1x 50,0x70,0

¹⁾ Hexagonal blade



Faster screwdriving

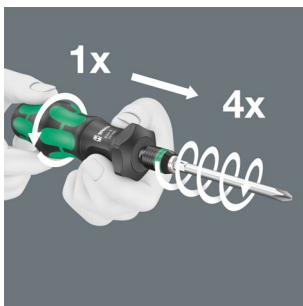

The construction of the Kraftform Turbo allows the speed of manual screwdriving to be quadrupled, especially for smooth couplings - without electricity!

With and without Turbo



The turbo function can be activated as needed by pressing a button. Turning it off is recommended for tightening and loosening with high torque, e.g. for screw connections in wood as well as for fine adjustments.

Handle/interchangeable blade system



Thanks to the Rapidaptor bit holder, the Kraftform Turbo can be used with all conventional 1/4" bits.

Storage and transport

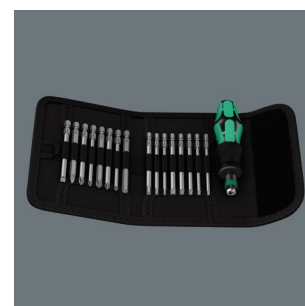

The tools can be stored a robust pouch. In this way the tool is always to hand.

Bit-Check 30 Universal 1



1 bit holder Rapidaptor with quick-release chuck, 29 bits, Torsion-style (T) design to reduce premature wear, tough (Z), for universal use, extra-hard (H).

05056440001	
⊙	889/4/1 K 1x 1/4"x50
+	851/1 TZ 2x PH 1x25; 3x PH 2x25; 1x PH 3x25
+	855/1 TH 2x PZ 1x25; 3x PZ 2x25; 1x PZ 3x25
⊕	867/1 TZ TORX® 1x TX 10x25; 1x TX 15x25; 1x TX 20x25; 1x TX 25x25; 1x TX 30x25; 1x TX 40x25
⊕	867/1 Z TORX® 1x TX 10x25; 1x TX 15x25; 1x TX 20x25; 1x TX 25x25; 1x TX 30x25
⊖	800/1 TZ 1x 1,0x5,5x25
⊙	840/1 Z 1x 3,0x25; 1x 4,0x25; 1x 5,0x25; 1x 6,0x25; 1x 8,0x25

Bit-Check 30 Zyklop Mini 1



28 bits, 1 Rapidaptor bit holder, 1 adaptor 870/1 (1/4" hexagon to 1/4" square), 1 Wera Bit Ratchet Zyklop Mini 1, drop-forged full steel design, suitable for 1/4" hex bits as per DIN ISO 1173-C 6.3 and E 6.3 and Wera series 1 and 4

05073640001	
⊙	8001 A 1x 1/4"x87,0
⊙	870/1 1x 1/4"x25 ¹⁾
⊙	889/4/1 K 1x 1/4"x50
+	851/1 TZ 2x PH 1x25; 3x PH 2x25; 1x PH 3x25
+	855/1 TH 1x PZ 1x25; 3x PZ 2x25; 1x PZ 3x25
⊕	867/1 TZ TORX® 1x TX 10x25; 1x TX 15x25; 1x TX 20x25; 1x TX 25x25; 1x TX 30x25; 1x TX 40x25
⊕	867/1 Z TORX® 1x TX 10x25; 1x TX 15x25; 1x TX 20x25; 1x TX 25x25; 1x TX 30x25
⊖	800/1 TZ 1x 1,0x5,5x25
⊙	840/1 Z 1x 3,0x25; 1x 4,0x25; 1x 5,0x25; 1x 6,0x25; 1x 8,0x25

¹⁾ With friction ball; for manual nut spinner sockets

Bit-Check 10 Zyklop Mini 1



9 bits, tough, for universal use, 1 Wera Bit Ratchet Zyklop Mini 1, drop-forged full steel design, suitable for 1/4" hex bits as per DIN ISO 1173-C 6.3 and E 6.3 and Wera series 1 and 4. Can also be used with 1/4" sockets by using the Wera socket adaptor 870/1.

05073645001	
⊙	8001 A 1x 1/4"x87,0
+	851/1 Z 1x PH 1x25; 1x PH 2x25
+	855/1 Z 1x PZ 1x25; 1x PZ 2x25
⊕	867/1 TORX® 1x TX 15x25; 1x TX 20x25; 1x TX 25x25
⊙	840/1 Z 1x 4,0x25; 1x 5,0x25

Bottle opener



With original Kraftform handle

	mm
05030005001	148

9500 Magnetiser SB



Application: Simply pull the tool along the positive side of the Wera magnetiser and the tool will hold the screw securely on the blade. To demagnetise, move the tool along the negative side.

	mm
05033404001	64,6

Wera 2go 2 Tool Container



1 dimensionally stable, robust Tool Container with hook and loop fastener system for the attachment of other Wera 2go components as well as Wera textile boxes and pouches with hook and loop fastener zones; high resistance against cuts and stabs; 1 handle and 1 Shoulder Strap with adjustable-width padding, adjustable in length, detachable; 1 removable Tool Quiver with handle and a variable hook and loop fastener partition for a division into as many as 5 inner sections.

05004351001		
	Wera 2go Container	1x 355,0x330,0x115,0
	Wera 2go 6	1x 38,0x1470,0
	Wera 2go 4	1x 165,0x165,0x105,0

Wera 2go 3 Tool Box

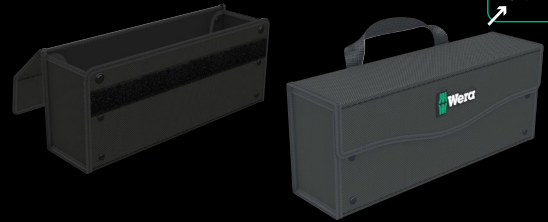

1 dimensionally stable and robust Tool Box, empty, equipped with handle for the storage and transport of tools and small parts; high resistance against cuts and stabs; comes with hook and loop fastener zone for docking with the Wera 2go system.

	mm	mm	mm
05004352001	130,0	325,0	80,0



Variable thanks to the hook and loop fastener system

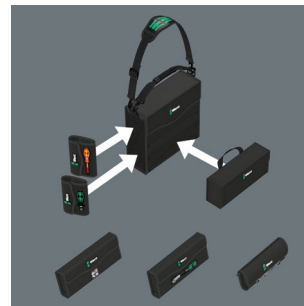

The inner and outer hook and loop fastener sections mean that other Wera 2go system components can be just as easily attached as all other Wera tools in boxes and pouches with hook and loop fastener zones. This enables an individual composition of the tools needed for a specific job.

Robust and dimensionally stable



The robust and dimensionally stable material protects the tools carried against damage and moisture and enhances the service life of the tool container.

Clever organisation



The variably adjustable hook and loop fastener partition in the Tool Quiver ensures neat and tidy arrangement of the tools.





Questions concerning your workshop
and workplace equipment?
Please contact us. We are happy to help.

No liability for printing errors or mistakes
shall be assumed.



Wera Werkzeuge GmbH
Korzterter Straße 21-25
D-42349 Wuppertal

Phone: +49 (0)202/40 45-0
E-Mail: info@wera.de
www.wera.de

Wera Tools (UK) LTD.
Railway View
Clay Cross, Chesterfield
Derbyshire, S45 9FR

Phone: +44 (0)1246 / 277756
eMail: queries@wera-tools.co.uk
www.weratools.co.uk

Wera Tools Inc. (North America)
4129 Harvester Rd, Unit H
Burlington, Ontario
Canada, L7L 5M3

Phone: 1-800-267-55 41
E-Mail: info@weratools.com
www.weratools.com

Wera Tools Australia Pty Ltd.

Phone: +61-435 755 123
E-Mail: mike.sack@wera.de

Wera Tools Japan G.K

Phone: +81 70 4813 1142
E-Mail: frank.yang@wera.de