

Roller cabinet and foam inserts

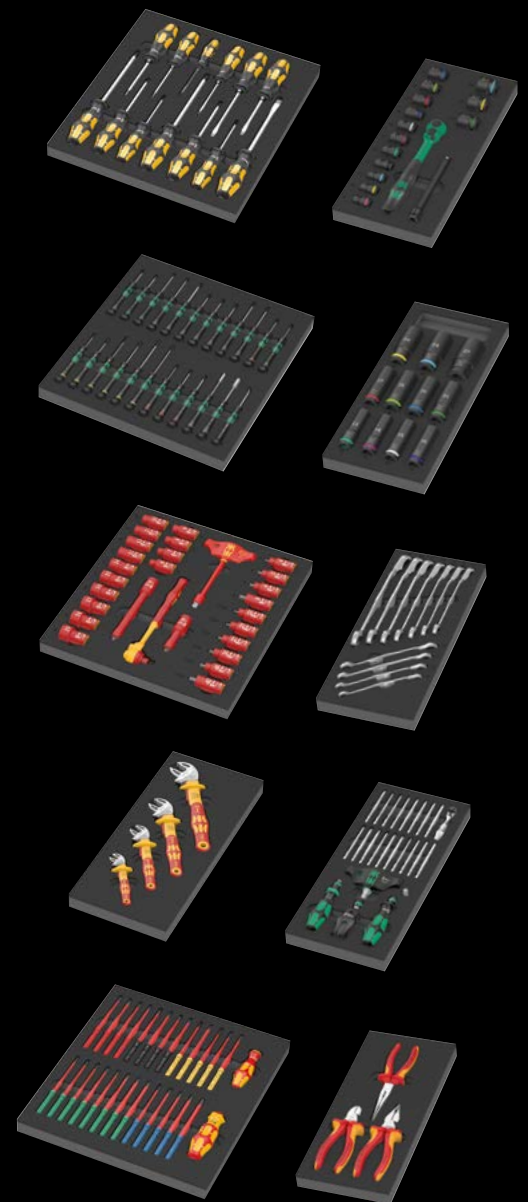

Top quality roller cabinet exclusively for Tool Rebels.

- Exclusive roller cabinet in the Tool Rebel design
- Extremely robust thanks to a double-walled design
- With 7 drawers (5 flat, 2 high) – of which 2 flat drawers are equipped with foam inserts and tools
- Dimensions flat drawers (width x height x depth): 522 x 81 x 398 mm
- Dimensions high drawers (width x height x depth): 522 x 166 x 398 mm
- 100 % drawer pull-out with ball bearing telescopic slides, self-closing
- All drawers are elaborately and individually layered
- Minimum risk of tilting over thanks to the drawer stop – only one drawer can be opened, no simultaneous pull-out of multiple drawers
- High-quality, durable foam inserts without chemical vapours
- Optimum fit for the best possible removal of the tools from the foam inserts





9700 Tool Rebel Roller Cabinet 1



Includes the following foam inserts:

9710



9720

1/4"

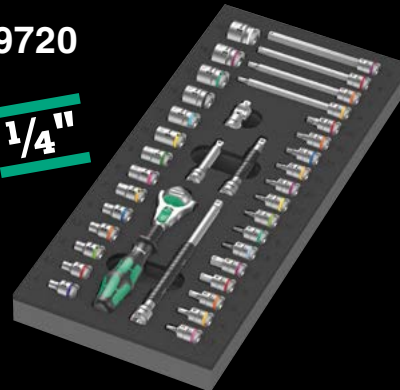

9731



9740



Exclusive roller cabinet in the Tool Rebel design. Five flat and two high drawers ensure efficient, mobile organization of tools and materials. Extremely robust design thanks to a double-walled design and the completely welded construction of the entire body. For daily hard work in the workshop. Equipped with four Wera foam inserts: 9710 foam insert screwdriver set 1, 9720 foam insert 8000 A Zyklop ratchet set 1, 9731 foam insert 6003 Joker ring spanner set 1, 9740 foam insert L-key set 1.

05150130001 1x 9700 Tool Rebel roller cabinet 1

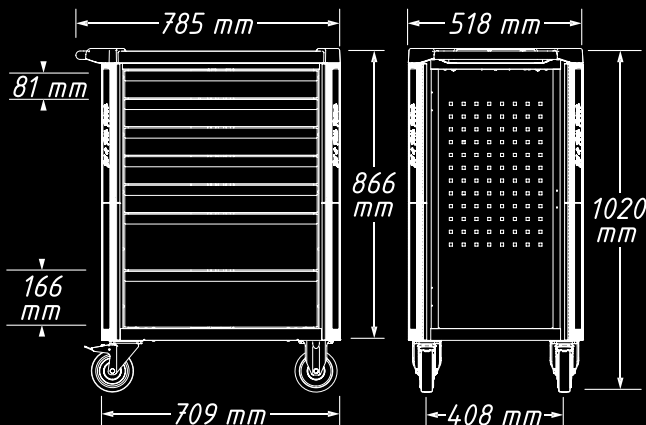

NEW

9714 Foam insert The Chiseldriver screwdriver set 1



05150105001		
+	917 SPH	1x PH 1x80; 1x PH 2x100; 1x PH 3x150
+	918 SPZ	1x PZ 1x80; 1x PZ 2x100; 1x PZ 3x150
-	932 A	1x 0,6x3,5x80 ¹⁾ ; 1x 0,8x4,5x90; 1x 1,0x5,5x100; 1x 1,2x7,0x125; 1x 1,6x9,0x150
+	977 TORX®	1x TX 20x90; 1x TX 25x100
	9814	1x 344,0x30,0x392,0

¹⁾ No throughout blade, no impact cap and no hexagon bolster

NEW

9715 Foam insert Kraftform Micro screwdriver set 1

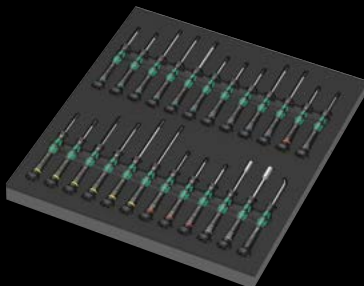

05150106001		
+	2050 Micro	1x PH 000x40 ^{1) 2)} ; 1x PH 00x40 ^{1) 2)} ; 1x PH 0x40 ³⁾
+	2067 TORX® HF	1x TX 5x40; 1x TX 6x40; 1x TX 7x60; 1x TX 8x60; 1x TX 10x60
+	2067 TORX PLUS® IPR Micro	1x 1 IPRx40 ⁴⁾
+	2072 Micro	1x mx40
○	2054 Micro	1x 0,7x40; 1x 0,9x40; 1x 1,3x40; 1x 1,5x60; 1x 2x60
-	2035 Micro	1x 0,23x1,5x40; 1x 0,30x1,8x60; 1x 0,35x2,5x40; 1x 0,40x2,0x60; 1x 0,40x2,5x80; 1x 0,50x3,0x80
●	2069 Micro	1x 4,0x60; 1x 5,5x60
●	1429	1x 1,0x3,5x50
	9815	1x 344,0x30,0x392,0

¹⁾ Optimised for Asian PH screws

²⁾ On the output side, the blade is turned to a nominal length of 10 mm

³⁾ Size 0 modified according to JCS 0 (Japanese Camera Industrial Standard)

⁴⁾ Without bore hole

NEW

9726 Foam insert 8007 B VDE Zyklop VDE ratchet set 1, 3/8"



05150116001		
○	8007 B VDE	1x 3/8"x222,0
○	410 i VDE B	1x 3/8"x130
●	8790 B VDE	1x 6,0x46,0; 1x 7,0x46,0; 1x 8,0x46,0; 1x 9,0x46,0; 1x 10,0x46,0; 1x 11,0x46,0; 1x 12,0x46,0; 1x 13,0x46,0; 1x 14,0x46,0; 1x 15,0x46,0; 1x 16,0x46,0; 1x 17,0x46,0; 1x 18,0x46,0; 1x 19,0x46,0
+	8767 B VDE HF	1x TX 20x55,0; 1x TX 25x55,0; 1x TX 27x55,0; 1x TX 30x55,0; 1x TX 40x55,0; 1x TX 45x59,0
○	8740 B VDE HF	1x 4,0x55,0; 1x 5,0x55,0; 1x 6,0x55,0; 1x 8,0x59,0
●	8794 SB VDE	1x 3/8"x91,0
●	8794 LB VDE	1x 3/8"x166,0
	9826	1x 344,0x30,0x392,0

NEW

9734 Foam insert 6004 Joker VDE set 1



05150124001		
	6004 Joker VDE XS	1x 7-10 (1/4"-3/8")x119
	6004 Joker VDE S	1x 10-13 (7/16"-1/2")x155
	6004 Joker VDE M	1x 13-16 (1/2"-5/8")x190
	6004 Joker VDE L	1x 16-19 (5/8"-3/4")x226
	9834	1x 172,0x30,0x392,0

Attention: The foam inserts do not fit in the previous model 05501051001 of the roller cabinet.

NEW

9751 Foam insert Kraftform Kompakt VDE set 1

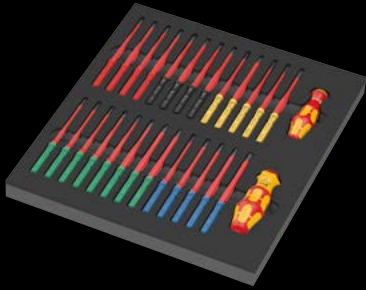

05150151001		
●	837 i RA	1x 9x115
●	817 VDE	1x 9x98
⊕	Kraftform Kompakt VDE 62 iS Take it easy	1x PH 1x157; 1x PH 2x157
⊕	Kraftform Kompakt VDE 65 iS Take it easy	1x PZ 1x157; 1x PZ 2x157
⊕	Kraftform Kompakt VDE 62 iS PH/S Take it easy	1x # 1x157; 1x # 2x157
⊕	Kraftform Kompakt VDE 65 iS PZ/S Take it easy	1x # 1x157; 1x # 2x157
⊕	Kraftform Kompakt VDE 67 i Take it easy	1x TX 8x157; 1x TX 9x157; 1x TX 10x157; 1x TX 27x157; 1x TX 30x157
⊕	Kraftform Kompakt VDE 67 iS Take it easy	1x TX 15x157; 1x TX 20x157; 1x TX 25x157
○	Kraftform Kompakt VDE 64 i Take it easy	1x 2,5x157; 1x 3,0x157; 1x 4,0x157; 1x 5,0x157; 1x 6,0x157
⊖	Kraftform Kompakt VDE 60 iS Take it easy	1x 0,6x3,5x157; 1x 0,8x4,0x157; 1x 1,0x5,5x157
⊖	Kraftform Kompakt VDE 60 i Take it easy	1x 0,4x2,5x157; 1x 1,2x6,5x157
	9851	1x 344,0x30,0x392,0

NEW

9724 Foam insert 8010 B Zyklop Comfort ratchet set 1, 3/8"



05150114001		
○	8010 B	1x 3/8"x230,0
●	8790 B Impaktor	1x 8,0x30,0; 1x 10,0x30,0; 1x 11,0x30,0; 1x 12,0x30,0; 1x 13,0x30,0; 1x 14,0x30,0; 1x 15,0x30,0; 1x 16,0x30,0; 1x 17,0x30,0; 1x 18,0x30,0; 1x 19,0x30,0; 1x 21,0x32,0; 1x 22,0x32,0; 1x 24,0x32,0
⊖	8798 B	1x 3/8"x152,4
	9824	1x 172,0x30,0x392,0

NEW

9725 Foam insert Zyklop C, 1/2", Impaktor Deep socket set 1



05150115001		
●	8790 C Impaktor Deep	1x 13,0x83,0; 1x 14,0x83,0; 1x 15,0x83,0; 1x 16,0x83,0; 1x 17,0x83,0; 1x 18,0x83,0; 1x 19,0x83,0; 1x 21,0x83,0; 1x 22,0x83,0; 1x 24,0x83,0; 1x 27,0x83,0
	9825	1x 172,0x30,0x392,0

NEW

9733 Foam insert 6001 Joker Switch set 1

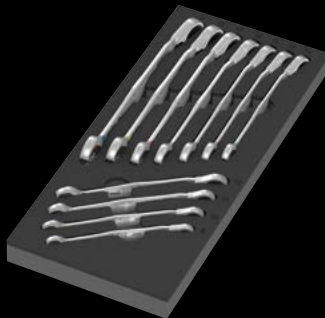

05150123001	
6001 Joker Switch	1x 8x144; 1x 10x159; 1x 11x165; 1x 12x171; 1x 13x179; 1x 14x187; 1x 15x199; 1x 16x213; 1x 17x225; 1x 18x234; 1x 19x246
9833	1x 172,0x30,0x392,0

NEW

9784 Foam insert KNIPEX pliers set VDE 1



05150184001	
KNIPEX Diagonal stripper 70 06 160	
KNIPEX Snipe nose pliers with blade (stork beak pliers) 26 16 200	
KNIPEX Needle-nose combination pliers 08 26 185	
9884	1x 172,0x30,0x392,0

NEW

9752 Foam insert Kraftform Kompakt with ratchet functionality set 1



1/4"

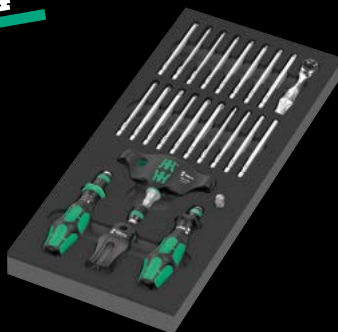

05150152001	
●	838 RA-R M 1x 1/4"x123,5
●	416 RA 1x 1/4"x45
●	816 R 1x 1/4"x119
●	8001 A 1x 1/4"x87,0
+	851/4 Z 1x PH 1x89; 1x PH 2x89; 1x PH 3x89 ¹⁾
+	855/4 Z 1x PZ 1x89; 1x PZ 2x89; 1x PZ 3x89 ¹⁾
+	867/4 Z TORX® 1x TX 10x89; 1x TX 15x89; 1x TX 20x89; 1x TX 25x89; 1x TX 27x89; 1x TX 30x89; 1x TX 40x89
○	840/4 Z 1x 3,0x89; 1x 4,0x89; 1x 5,0x89; 1x 6,0x89 ¹⁾
●	800/4 Z 1x 1,0x5,5x89
○	870/1 1x 1/4"x25 ²⁾
	9500 1x 64,6
	9852 1x 172,0x30,0x392,0

¹⁾ Hexagonal blade

²⁾ With friction ball; for manual nut spinner sockets

9710 Foam insert screwdriver set 1

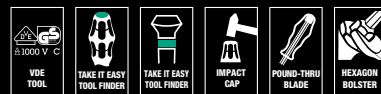

05150101001	
●	932 A 1x 1,0x5,5x100; 1x 1,2x7,0x125
+	350 PH 1x PH 1x80; 1x PH 2x100; 1x PH 3x150
+	350 PH Stubby/carburetor screwdriver 1x PH 2x25
+	355 PZ 1x PZ 1x80; 1x PZ 2x100
●	335 1x 0,8x4,0x100; 1x 1,0x5,5x125
●	334 1x 1,2x6,5x150
●	335 Stubby/carburetor screwdriver 1x 1,0x5,5x24,5
+	2050 Micro 1x PH 0x40 ¹⁾
●	2035 Micro 1x 0,40x2,5x80
●	160 i VDE 1x 0,4x2,5x80 ²⁾ ; 1x 0,6x3,5x100 ²⁾
	1441 1x 4,5-6,0x41,0
	1442 1x 6,0-8,5x41,0
	9810 1x 344,0x30,0x392,0

¹⁾ Size 0 modified according to JCIS 0 (Japanese Camera Industrial Standard)

²⁾ without Lasertip

9711 Foam insert VDE screwdriver set 1

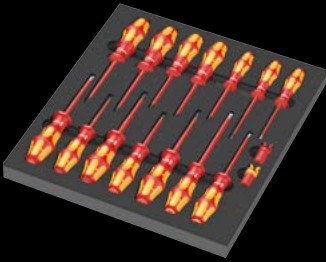

05150102001	
+	162 iS PH VDE 1x PH 1x80; 1x PH 2x100
+	165 iS PZ VDE 1x PZ 1x80; 1x PZ 2x100
+	165 i PZ/S VDE 1x # 2x100
-	160 i VDE 1x 0,4x2,5x80 ¹⁾ ; 1x 0,8x4,0x100; 1x 1,0x5,5x125
-	160 iS VDE 1x 0,6x3,5x100
+	167 i TORX® VDE 1x TX 10x80; 1x TX 15x80; 1x TX 20x80; 1x TX 25x100; 1x TX 30x100
	1440 1x 4,5-6,0x41,0
	1442 1x 6,0-8,5x41,0
	9811 1x 344,0x30,0x392,0

¹⁾ without Lasertip

9713 Foam insert Hex screwdriver set 1

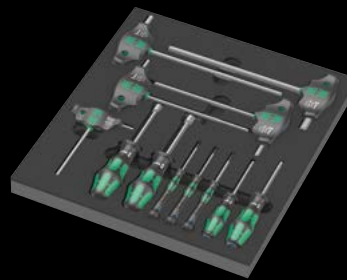

05150104001	
○	354 1x 3,0x75; 1x 4,0x75
○	2054 Micro 1x 1,5x60; 1x 2x60; 1x 2,5x60
○	454 HF 1x 4x100; 1x 5x100; 1x 6x150; 1x 8x200; 1x 10x200
●	395 H0 1x 10,0x90; 1x 13,0x90
	9813 1x 344,0x30,0x392,0

9720 Foam insert 8000 A Zyklop 1/4" ratchet set 1



9712 Foam insert TORX® HF screwdriver set 1

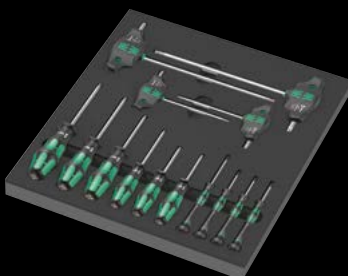

05150103001	
+	367 TORX® HF 1x TX 8x60; 1x TX 9x60; 1x TX 10x80; 1x TX 15x80; 1x TX 20x100; 1x TX 25x100
+	2067 TORX® HF 1x TX 4x40; 1x TX 5x40; 1x TX 6x40; 1x TX 7x60
+	467 TORX® HF 1x TX 20x100; 1x TX 25x100; 1x TX 30x200; 1x TX 40x200
	9812 1x 344,0x30,0x392,0

05150110001	
○	8000 A 1x 1/4"x152,0
●○	8794 LA 1x 1/4"x150,0
●○	8794 SA 1x 1/4"x75,0
●○	8795 A 1x 1/4"x35,5
●○	8794 A 1x 1/4"x56,0
●	8790 HMA 1x 4,0x23,0; 1x 4,5x23,0; 1x 5,0x23,0; 1x 5,5x23,0; 1x 6,0x23,0; 1x 7,0x23,0; 1x 8,0x23,0; 1x 9,0x23,0; 1x 10,0x23,0; 1x 11,0x23,0; 1x 12,0x23,0; 1x 13,0x23,0; 1x 14,0x23,0; 1x 15,0x23,0
+	8767 A HF 1x TX 8x28,0; 1x TX 9x28,0; 1x TX 10x28,0; 1x TX 15x28,0; 1x TX 20x28,0; 1x TX 25x28,0; 1x TX 27x28,0; 1x TX 30x28,0; 1x TX 40x28,0
○	8740 A HF 1x 3,0x28,0; 1x 4,0x28,0; 1x 4,0x100,0; 1x 5,0x28,0; 1x 5,0x100,0; 1x 6,0x28,0; 1x 6,0x100,0; 1x 8,0x28,0; 1x 8,0x100,0
	9820 1x 172,0x30,0x392,0

9721 Foam insert 8000 B Zyklop 3/8" ratchet set 1



3/8"



05150111001		
○	8000 B	1x 3/8"x199,0
●○	8794 SB	1x 3/8"x125,0
●○	8794 LB	1x 3/8"x200,0
●○	8795 B	1x 3/8"x50,0
●○	8794 B	1x 3/8"x76,0
●	8790 HMB	1x 6,0x29,0; 1x 7,0x29,0; 1x 8,0x29,0; 1x 9,0x29,0; 1x 10,0x29,0; 1x 11,0x29,0; 1x 12,0x29,0; 1x 13,0x29,0; 1x 14,0x29,0; 1x 15,0x29,0; 1x 16,0x30,0; 1x 17,0x30,0; 1x 18,0x30,0; 1x 19,0x30,0; 1x 20,0x30,0; 1x 21,0x30,0; 1x 22,0x30,0; 1x 24,0x32,0
	9821	1x 172,0x30,0x392,0

9723 Foam insert Zyklop B 3/8" bit socket set 1



3/8"



05150113001		
●●	8784 B1	1x 1/4"x3/8"x44,0
⊗	8767 B HF	1x TX 15x35,0; 1x TX 20x35,0; 1x TX 25x35,0; 1x TX 25x107,0; 1x TX 27x35,0; 1x TX 27x107,0; 1x TX 30x35,0; 1x TX 30x107,0; 1x TX 40x35,0; 1x TX 40x107,0
○	8740 B HF	1x 4,0x35,0; 1x 4,0x107,0; 1x 5,0x35,0; 1x 5,0x107,0; 1x 6,0x35,0; 1x 6,0x107,0; 1x 7,0x38,5; 1x 8,0x38,5; 1x 8,0x100,0; 1x 10,0x38,5; 1x 10,0x100,0
	9823	1x 172,0x30,0x392,0

9722 Foam insert 8000 C Zyklop 1/2" ratchet set 1



1/2"



05150112001		
○	8000 C	1x 1/2"x277,0
●○	8794 LC	1x 1/2"x250,0
●○	8794 SC	1x 1/2"x125,0
●○	8795 C	1x 1/2"x69,0
●○	8794 C	1x 1/2"x52,0
●	8790 HMC	1x 10,0x37,0; 1x 11,0x37,0; 1x 12,0x37,0; 1x 13,0x37,0; 1x 14,0x37,0; 1x 15,0x37,0; 1x 16,0x37,0; 1x 17,0x37,0; 1x 18,0x37,0; 1x 19,0x37,0; 1x 20,0x37,0; 1x 21,0x37,0; 1x 22,0x37,0; 1x 24,0x37,0; 1x 27,0x40,0; 1x 30,0x42,0; 1x 32,0x42,0
○	8740 C HF	1x 4,0x60,0; 1x 4,0x140,0; 1x 5,0x60,0; 1x 5,0x140,0; 1x 6,0x60,0; 1x 6,0x140,0; 1x 7,0x60,0; 1x 8,0x60,0; 1x 10,0x60,0
	9822	1x 344,0x30,0x392,0

9730 Foam insert 6000 Joker set 1



05150120001		
	6000 Joker	1x 8x144; 1x 10x159; 1x 11x165; 1x 12x170,7; 1x 13x177; 1x 14x188; 1x 15x200; 1x 16x212; 1x 17x224; 1x 18x235; 1x 19x246
	9830	1x 172,0x30,0x392,0

9731 Foam insert 6003 Joker set 1



05150121001	
6003 Joker	1x 6x105; 1x 7x110; 1x 8x115; 1x 9x120; 1x 10x125; 1x 11x135; 1x 12x148; 1x 13x160; 1x 14x167; 1x 15x174; 1x 16x182; 1x 17x190; 1x 18x210; 1x 19x230,0; 1x 20x230,0; 1x 21x260; 1x 22x260; 1x 24x280
Bottle opener	1x 148
9831	1x 344,0x30,0x392,0

9732 Foam insert 6004 Joker set 1



05150122001	
6004 Joker XS	1x 7-10 (1/4"-3/8")x117
6004 Joker S	1x 10-13 (7/16"-1/2")x154
6004 Joker M	1x 13-16 (1/2"-5/8")x188
6004 Joker L	1x 16-19 (5/8"-3/4")x224
6004 Joker XL	1x 19-24x (3/4"-15/16")x256
9832	1x 172,0x30,0x392,0

9740 Foam insert L-key set 1

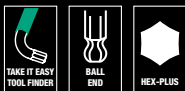

05150140001	
950 SPKL Multicolour	1x 1.5x90; 1x 2.0x101; 1x 2.5x112; 1x 3.0x123; 1x 4.0x137; 1x 5.0x154; 1x 6.0x172; 1x 8.0x195; 1x 10.0x224
967 SXL TORX® Multicolour	1x TX 8x90; 1x TX 9x101; 1x TX 10x112
967 SPKXL TORX® Multicolour	1x TX 15x123; 1x TX 20x137; 1x TX 25x154; 1x TX 27x172; 1x TX 30x195; 1x TX 40x224
9500	1x 64,6
STABILA® BM 100 Pocket tape, metric scale, 3 m, item 19570	1x 3000,0
9840	1x 172,0x30,0x392,0

9750 Foam insert Kraftform Kompakt and Tool-Check PLUS set 1



05150150001	
1x Tool-Check PLUS	
● 8001 A	1x 1/4"x87.0
● 813	1x 1/4"x78
● 889/4/1 K	1x 1/4"x50
○ 870/1	1x 1/4"x25 ¹⁾
● 8790 HMA	1x 5.5x23.0; 1x 6.0x23.0; 1x 7.0x23.0; 1x 8.0x23.0; 1x 10.0x23.0; 1x 12.0x23.0; 1x 13.0x23.0
⊕ 851/1 TZ	2x PH 1x25; 3x PH 2x25; 1x PH 3x25
⊕ 855/1 TH	1x PZ 1x25; 3x PZ 2x25; 1x PZ 3x25
⊕ 867/1 TZ TORX®	1x TX 10x25; 1x TX 15x25; 1x TX 20x25; 1x TX 25x25; 1x TX 30x25; 1x TX 40x25
⊕ 867/1 Z TORX® BO	1x TX 10x25; 1x TX 15x25; 1x TX 20x25; 1x TX 25x25; 1x TX 30x25
○ 840/1 Z	1x 3.0x25; 1x 4.0x25; 1x 5.0x25; 1x 6.0x25; 1x 8.0x25
⊖ 800/1 TZ	1x 1.0x5.5x25
1x Kraftform Kompakt 60	
● 816 R	1x 1/4"x119
⊕ 851/4 Z	1x PH 1x89; 1x PH 2x89; 1x PH 3x89 ²⁾
⊕ 855/4 Z	1x PZ 1x89; 1x PZ 2x89; 1x PZ 3x89 ²⁾
⊕ 867/4 Z TORX® BO	1x TX 10x89; 1x TX 15x89; 1x TX 20x89; 1x TX 25x89; 1x TX 30x89
⊖ 800/4 Z	1x 1.0x5.5x89
○ 840/4 Z	1x 3.0x89; 1x 4.0x89; 1x 5.0x89; 1x 6.0x89 ²⁾
Hook and Loop Fastener Strip 70	1x 50.0x70.0
1x 393 S	
●	1x 1/4"x173,5
1x 9850	
	1x 172,0x30,0x392,0

¹⁾ With friction ball; for manual nut spinner sockets
²⁾ Hexagonal blade

9780 Foam insert KNIPEX pliers set 1



05150180001		
	KNIPEX Com- bination Pliers 03 05 180	1x 180
	KNIPEX Cobra® High- Tech Water Pump Pliers 87 05 250	1x 250
	KNIPEX High Leverage Di- agonal Cutter 74 05 160	1x 160
	9880	1x 172,0x30,0x392,0

9782 Foam insert hammer set 1



05150182001		
	PICARD® riveting ham- mer 500 g, 0000101-500	1x 500,0
	RENNSTEIG Parallel pin punches Exclusive	1x 452 003 6 RC, 3,0x150; 1x4520046RC, 4,0x150; 1x4520066RC, 6,0x150; 1x 452 008 6 RC, 8,0x150
	RENNSTEIG Flat cold chis- el 310 250 1	1x 25,0x13,0x23,0
	9882	1x 172,0x30,0x392,0

9781 Foam insert KNIPEX pliers set 2

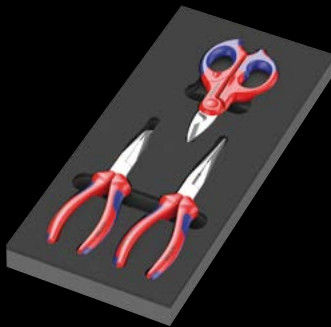

05150181001		
	KNIPEX Snipe Nose Cutting Pliers (Stork Beak Pliers) 26 15 200	1x 200
	KNIPEX Me- chanics' Pliers 38 25 200	1x 200
	KNIPEX Electricians' Shears 95 05 155	1x 155
	9881	1x 172,0x30,0x392,0

9783 Foam insert PFERD file set 1

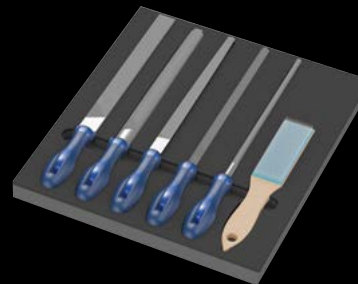

05150183001		
	PFERD machinist's file square PF1142 250 H2	1x 250
	PFERD machinist's file half-round pointed 1152SP 250 H2	1x 250
	PFERD ma- chinist's file round 1162 250 H2	1x 250
	PFERD machinist's file hand 1112 250 H2	1x 250
	PFERD ma- chinist's file three square 1132 250 H2	1x 250
	PFERD scratch brush HBF steel wire Ø 0.15	1x 232
	9883	1x 344,0x30,0x392,0

No liability for printing errors or mistakes
shall be assumed.



Wera Werkzeuge GmbH
Korzenter Straße 21-25
D-42349 Wuppertal

Phone: +49 (0)202/40 45-0
E-Mail: info@wera.de
www.wera.de



EV/081.05 510285 024 - 0053701 - 01