

Carro de las herramientas para el taller y depósitos de espuma de espuma

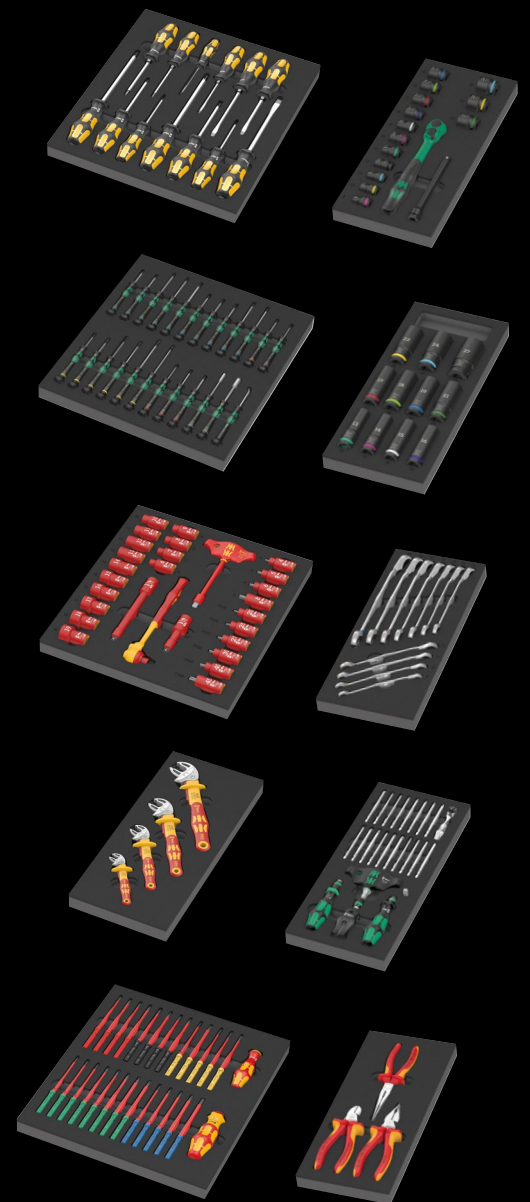

Un carro de herramientas para el taller, que incluye las herramientas, en un diseño frontal genial y de una calidad absolutamente puntera.

- Carro de herramientas para el taller exclusivo en el diseño Tool Rebel.
- Una versión extremadamente robusta gracias a la construcción de doble pared
- Con 7 cajones (5 planos, 2 altos): de estos, 2 cajones planos llevan depósitos de espuma incluyendo las herramientas
- Medidas de cajones planos (anchura x altura x profundidad): 522 x 81 x 398 mm
- Las medidas de los cajones altos: (anchura x altura x profundidad): 522 x 166 x 398 mm
- Apertura de los cajones en un 100 % con rieles telescópicos de rodamientos de bola, cierre automático
- En un proceso laborioso, todos los cajones han recibido un revestimiento individual
- Un riesgo de vuelco mínimo gracias al bloqueo de extracción – solo un cajón se puede abrir a la vez, no es posible abrir varios cajones al mismo tiempo
- Depósitos de espuma de alta calidad y de larga duración sin evaporaciones químicas
- Un encaje perfecto para facilitar y optimizar la extracción de la herramienta de los depósitos de espuma





9700 Carro de herramientas Tool Rebel 1



Incluye los siguientes depósitos de espuma:

9710



9720

1/4"

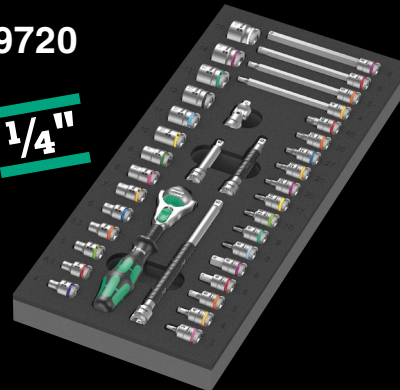

9731



9740



Un carro de herramientas para el taller, exclusivo en el diseño tipo Tool Rebel. Con 5 cajones planos y 2 cajones altos que permiten una organización eficaz y móvil de herramientas y materiales. El carro es extremadamente robusto ya que dispone de una pared doble y un cuerpo metálico completamente soldado. Es perfectamente adecuado para el trajín diario del trabajo en un taller. Está equipado con 4 piezas de espuma para depositar la herramienta: 9710 Depósito de espuma juego de destornilladores Set 1, 9720 Depósito de espuma 8000 A juego de carracas Zyklop Set 1, 9731 Depósito de espuma 6003 juego de llave de boca y anillo Joker Set 1, 9740 Depósito de espuma juego de llaves acodadas Set 1.

05150130001 1x 9700 Carro de herramientas Tool Rebel 1

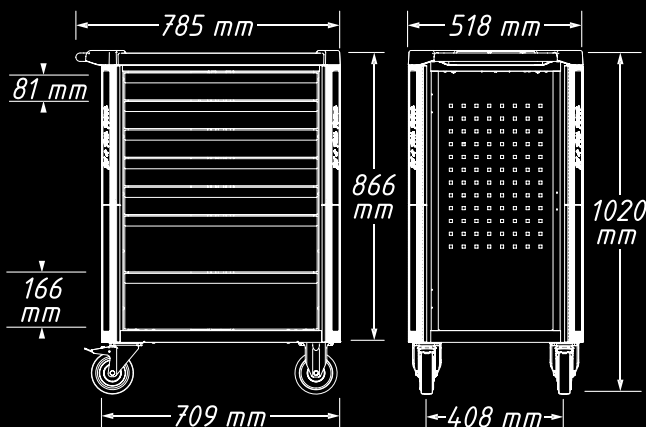

NUEVO

9714 Depósito de espuma juego de destornilladores "El destorcincel" Set 1

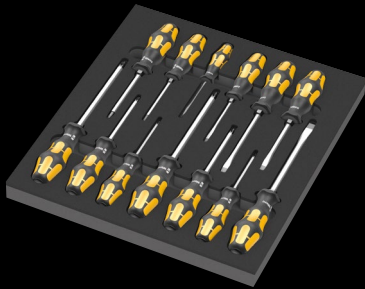

05150105001		
+	917 SPH	1x PH 1x80; 1x PH 2x100; 1x PH 3x150
+	918 SPZ	1x PZ 1x80; 1x PZ 2x100; 1x PZ 3x150
-	932 A	1x 0,6x3,5x80 ¹⁾ ; 1x 0,8x4,5x90; 1x 1,0x5,5x100; 1x 1,2x7,0x125; 1x 1,6x9,0x150
+	977 TORX®	1x TX 20x90; 1x TX 25x100
	9814	1x 344,0x30,0x392,0

¹⁾ Sin varilla pasante, cápsula de impacto y hexágono para llave

NUEVO

9715 Depósito de espuma juego de destornilladores Kraftform Micro Set 1

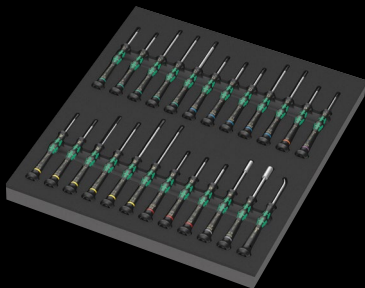

05150106001		
+	2050 Micro	1x PH 000x40 ^{1) 2)} ; 1x PH 00x40 ^{1) 2)} ; 1x PH 0x40 ³⁾
+	2067 TORX® HF	1x TX 5x40; 1x TX 6x40; 1x TX 7x60; 1x TX 8x60; 1x TX 10x60
+	2067 TORX PLUS® IPR Micro	1x 1 IPRx40 ⁴⁾
+	2072 Micro	1x mx40
○	2054 Micro	1x 0,7x40; 1x 0,9x40; 1x 1,3x40; 1x 1,5x60; 1x 2x60
-	2035 Micro	1x 0,23x1,5x40; 1x 0,30x1,8x60; 1x 0,35x2,5x40; 1x 0,40x2,0x60; 1x 0,40x2,5x80; 1x 0,50x3,0x80
●	2069 Micro	1x 4,0x60; 1x 5,5x60
●	1429	1x 1,0x3,5x50
	9815	1x 344,0x30,0x392,0

¹⁾ Optimizado para tornillos Phillips asiáticos

²⁾ En el lado de salida, la varilla está torneada a la medida nominal a lo largo de 10 mm

³⁾ El tamaño 0 corresponde a JCS 0 (Japanese Camera Industrial Standard) modificado

⁴⁾ Sin taladro

NUEVO

9726 Depósito de espuma juego de carraca 8007 B VDE Zyklop VDE Set 1, 3/8"



05150116001		
○	8007 B VDE	1x 3/8"x222,0
○	410 i VDE B	1x 3/8"x130
●	8790 B VDE	1x 6,0x46,0; 1x 7,0x46,0; 1x 8,0x46,0; 1x 9,0x46,0; 1x 10,0x46,0; 1x 11,0x46,0; 1x 12,0x46,0; 1x 13,0x46,0; 1x 14,0x46,0; 1x 15,0x46,0; 1x 16,0x46,0; 1x 17,0x46,0; 1x 18,0x46,0; 1x 19,0x46,0
+	8767 B VDE HF	1x TX 20x55,0; 1x TX 25x55,0; 1x TX 27x55,0; 1x TX 30x55,0; 1x TX 40x55,0; 1x TX 45x59,0
○	8740 B VDE HF	1x 4,0x55,0; 1x 5,0x55,0; 1x 6,0x55,0; 1x 8,0x59,0
○	8794 SB VDE	1x 3/8"x91,0
○	8794 LB VDE	1x 3/8"x166,0
	9826	1x 344,0x30,0x392,0

NUEVO

9734 Depósito de espuma 6004 juego de llaves de boca autoajustable Joker VDE Set 1



05150124001		
	6004 Joker VDE XS	1x 7-10 (1/4"-3/8")x119
	6004 Joker VDE S	1x 10-13 (7/16"-1/2")x155
	6004 Joker VDE M	1x 13-16 (1/2"-5/8")x190
	6004 Joker VDE L	1x 16-19 (5/8"-3/4")x226
	9834	1x 172,0x30,0x392,0

Atención: los depósitos de espuma no caben en el modelo anterior 05501051001 del carro de las herramientas para el taller.

NUEVO

9751 Depósito de espuma juego Kraftform Kompakt VDE Set 1

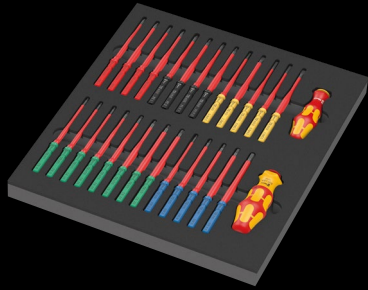

05150151001		
●	837 i RA	1x 9x115
●	817 VDE	1x 9x98
⊕	Kraftform Kompakt VDE 62 iS Take it easy	1x PH 1x157; 1x PH 2x157
⊕	Kraftform Kompakt VDE 65 iS Take it easy	1x PZ 1x157; 1x PZ 2x157
⊕	Kraftform Kompakt VDE 62 iS PH/S Take it easy	1x # 1x157; 1x # 2x157
⊕	Kraftform Kompakt VDE 65 iS PZ/S Take it easy	1x # 1x157; 1x # 2x157
⊕	Kraftform Kompakt VDE 67 i Take it easy	1x TX 8x157; 1x TX 9x157; 1x TX 10x157; 1x TX 27x157; 1x TX 30x157
⊕	Kraftform Kompakt VDE 67 iS Take it easy	1x TX 15x157; 1x TX 20x157; 1x TX 25x157
○	Kraftform Kompakt VDE 64 i Take it easy	1x 2,5x157; 1x 3,0x157; 1x 4,0x157; 1x 5,0x157; 1x 6,0x157
⊖	Kraftform Kompakt VDE 60 iS Take it easy	1x 0,6x3,5x157; 1x 0,8x4,0x157; 1x 1,0x5,5x157
⊖	Kraftform Kompakt VDE 60 i Take it easy	1x 0,4x2,5x157; 1x 1,2x6,5x157
	9851	1x 344,0x30,0x392,0

NUEVO

9724 Depósito de espuma juego de carraca 8010 B Zyklop Comfort Set 1, 3/8"



05150114001		
○	8010 B	1x 3/8"x230,0
●	8790 B Impaktor	1x 8,0x30,0; 1x 10,0x30,0; 1x 11,0x30,0; 1x 12,0x30,0; 1x 13,0x30,0; 1x 14,0x30,0; 1x 15,0x30,0; 1x 16,0x30,0; 1x 17,0x30,0; 1x 18,0x30,0; 1x 19,0x30,0; 1x 21,0x32,0; 1x 22,0x32,0; 1x 24,0x32,0
●○	8798 B	1x 3/8"x152,4
	9824	1x 172,0x30,0x392,0

NUEVO

9725 Depósito de espuma juego de llaves de vaso Zyklop C, 1/2", Impaktor Deep Set 1

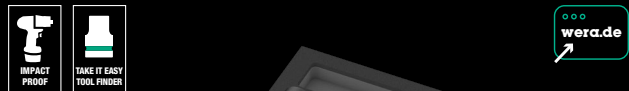

05150115001		
●	8790 C Impaktor Deep	1x 13,0x83,0; 1x 14,0x83,0; 1x 15,0x83,0; 1x 16,0x83,0; 1x 17,0x83,0; 1x 18,0x83,0; 1x 19,0x83,0; 1x 21,0x83,0; 1x 22,0x83,0; 1x 24,0x83,0; 1x 27,0x83,0
	9825	1x 172,0x30,0x392,0

NUEVO

9733 Depósito de espuma juego de llaves combinadas con carraca 6001 Joker Switch Set 1

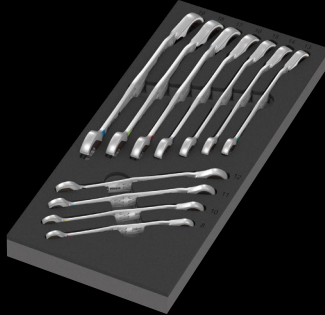

05150123001	
6001 Joker Switch	1x 8x144; 1x 10x159; 1x 11x165; 1x 12x171; 1x 13x179; 1x 14x187; 1x 15x199; 1x 16x213; 1x 17x225; 1x 18x234; 1x 19x246
9833	1x 172,0x30,0x392,0

NUEVO

9784 Depósito de espuma juego de alicates KNIPEX Set VDE 1



05150184001	
KNIPEX Alicates de corte diagonal 70 06 160	
KNIPEX Alicates de montaje (alicates de boca cigüeña) 26 16 200	
KNIPEX Alicates universal en punta 08 26 185	
9884	1x 172,0x30,0x392,0

NUEVO

9752 Depósito de espuma juego de Kraftform Kompakt con función de carraca Set 1



1/4"

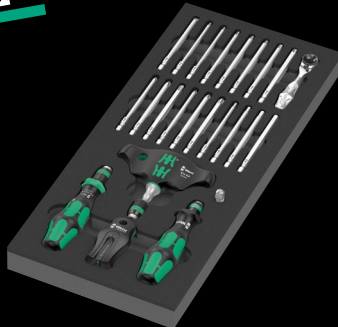

05150152001	
838 RA-R M	1x 1/4"x123,5
416 RA	1x 1/4"x45
816 R	1x 1/4"x119
8001 A	1x 1/4"x87,0
851/4 Z	1x PH 1x89; 1x PH 2x89; 1x PH 3x89 ¹⁾
855/4 Z	1x PZ 1x89; 1x PZ 2x89; 1x PZ 3x89 ¹⁾
867/4 Z TORX®	1x TX 10x89; 1x TX 15x89; 1x TX 20x89; 1x TX 25x89; 1x TX 27x89; 1x TX 30x89; 1x TX 40x89
840/4 Z	1x 3,0x89; 1x 4,0x89; 1x 5,0x89; 1x 6,0x89 ¹⁾
800/4 Z	1x 1,0x5,5x89
870/1	1x 1/4"x25 ²⁾
9500	1x 64,6
9852	1x 172,0x30,0x392,0

¹⁾ Varilla hexagonal

²⁾ Con bola; para llaves de vaso de uso manual

9710 Depósito de espuma juego de destornilladores Set 1

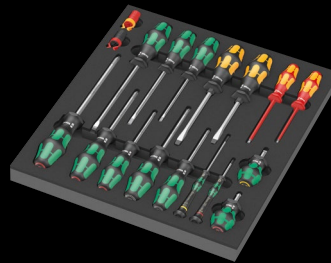

05150101001	
932 A	1x 1,0x5,5x100; 1x 1,2x7,0x125
350 PH	1x PH 1x80; 1x PH 2x100; 1x PH 3x150
350 PH Stubby	1x PH 2x25
355 PZ	1x PZ 1x80; 1x PZ 2x100
335	1x 0,8x4,0x100; 1x 1,0x5,5x125
334	1x 1,2x6,5x150
335 Stubby/ Destornillador corto	1x 1,0x5,5x24,5
2050 Micro	1x PH 0x40 ¹⁾
2035 Micro	1x 0,40x2,5x80
160 i VDE	1x 0,4x2,5x80 ²⁾ ; 1x 0,6x3,5x100 ²⁾
1441	1x 4,5-6,0x41,0
1442	1x 6,0-8,5x41,0
9810	1x 344,0x30,0x392,0

¹⁾ El tamaño 0 corresponde a JCIS 0 (Japanese Camera Industrial Standard) modificado

²⁾ sin Lasertip

9711 Depósito de espuma juego de destornilladores VDE Set 1

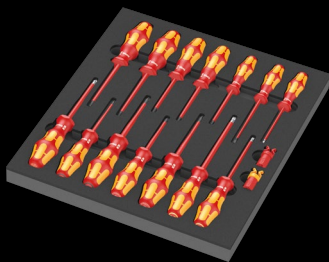

05150102001	
+	162 iS PH VDE 1x PH 1x80; 1x PH 2x100
+	165 iS PZ VDE 1x PZ 1x80; 1x PZ 2x100
+	165 i PZ/S VDE 1x # 2x100
-	160 i VDE 1x 0,4x2,5x80 ¹⁾ ; 1x 0,8x4,0x100; 1x 1,0x5,5x125
-	160 iS VDE 1x 0,6x3,5x100
+	167 i TORX® VDE 1x TX 10x80; 1x TX 15x80; 1x TX 20x80; 1x TX 25x100; 1x TX 30x100
	1440 1x 4,5-6,0x41,0
	1442 1x 6,0-8,5x41,0
	9811 1x 344,0x30,0x392,0

¹⁾ sin Lasertip

9713 Depósito de espuma juego de destornilladores Hex Set 1

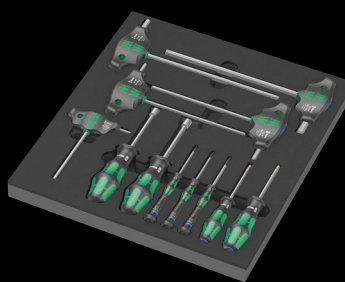

05150104001	
○	354 1x 3,0x75; 1x 4,0x75
○	2054 Micro 1x 1,5x60; 1x 2x60; 1x 2,5x60
○	454 HF 1x 4x100; 1x 5x100; 1x 6x150; 1x 8x200; 1x 10x200
●	395 H0 1x 10,0x90; 1x 13,0x90
	9813 1x 344,0x30,0x392,0

9720 Depósito de espuma juego de carraca Zyklop 8000 A de 1/4" Set 1



9712 Depósito de espuma juego de destornilladores TORX® HF Set 1

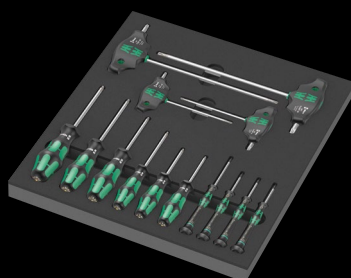

05150103001	
+	367 TORX® HF 1x TX 8x60; 1x TX 9x60; 1x TX 10x80; 1x TX 15x80; 1x TX 20x100; 1x TX 25x100
+	2067 TORX® HF 1x TX 4x40; 1x TX 5x40; 1x TX 6x40; 1x TX 7x60
+	467 TORX® HF 1x TX 20x100; 1x TX 25x100; 1x TX 30x200; 1x TX 40x200
	9812 1x 344,0x30,0x392,0

05150110001	
○	8000 A 1x 1/4"x152,0
●○	8794 LA 1x 1/4"x150,0
●○	8794 SA 1x 1/4"x75,0
●○	8795 A 1x 1/4"x35,5
●○	8794 A 1x 1/4"x56,0
●	8790 HMA 1x 4,0x23,0; 1x 4,5x23,0; 1x 5,0x23,0; 1x 5,5x23,0; 1x 6,0x23,0; 1x 7,0x23,0; 1x 8,0x23,0; 1x 9,0x23,0; 1x 10,0x23,0; 1x 11,0x23,0; 1x 12,0x23,0; 1x 13,0x23,0; 1x 14,0x23,0; 1x 15,0x23,0
+	8767 A HF 1x TX 8x28,0; 1x TX 9x28,0; 1x TX 10x28,0; 1x TX 15x28,0; 1x TX 20x28,0; 1x TX 25x28,0; 1x TX 27x28,0; 1x TX 30x28,0; 1x TX 40x28,0
○	8740 A HF 1x 3,0x28,0; 1x 4,0x28,0; 1x 4,0x100,0; 1x 5,0x28,0; 1x 5,0x100,0; 1x 6,0x28,0; 1x 6,0x100,0; 1x 8,0x28,0; 1x 8,0x100,0
	9820 1x 172,0x30,0x392,0

9721 Depósito de espuma juego de carraca Zyklop 8000 B de 3/8" Set 1



05150111001		
○	8000 B	1x 3/8"x199,0
●○	8794 SB	1x 3/8"x125,0
●○	8794 LB	1x 3/8"x200,0
●○	8795 B	1x 3/8"x50,0
●○	8794 B	1x 3/8"x76,0
●	8790 HMB	1x 6,0x29,0; 1x 7,0x29,0; 1x 8,0x29,0; 1x 9,0x29,0; 1x 10,0x29,0; 1x 11,0x29,0; 1x 12,0x29,0; 1x 13,0x29,0; 1x 14,0x29,0; 1x 15,0x29,0; 1x 16,0x30,0; 1x 17,0x30,0; 1x 18,0x30,0; 1x 19,0x30,0; 1x 20,0x30,0; 1x 21,0x30,0; 1x 22,0x30,0; 1x 24,0x32,0
	9821	1x 172,0x30,0x392,0

9723 Depósito de espuma juego Zyklop B 3/8" vaso de puntas Set 1



05150113001		
●●	8784 B1	1x 1/4"x3/8"x44,0
⊗	8767 B HF	1x TX 15x35,0; 1x TX 20x35,0; 1x TX 25x35,0; 1x TX 25x107,0; 1x TX 27x35,0; 1x TX 27x107,0; 1x TX 30x35,0; 1x TX 30x107,0; 1x TX 40x35,0; 1x TX 40x107,0
○	8740 B HF	1x 4,0x35,0; 1x 4,0x107,0; 1x 5,0x35,0; 1x 5,0x107,0; 1x 6,0x35,0; 1x 6,0x107,0; 1x 7,0x38,5; 1x 8,0x38,5; 1x 8,0x100,0; 1x 10,0x38,5; 1x 10,0x100,0
	9823	1x 172,0x30,0x392,0

9722 Depósito de espuma juego de carraca Zyklop 8000 C de 1/2" Set 1



05150112001		
○	8000 C	1x 1/2"x277,0
●○	8794 LC	1x 1/2"x250,0
●○	8794 SC	1x 1/2"x125,0
●○	8795 C	1x 1/2"x69,0
●○	8794 C	1x 1/2"x52,0
●	8790 HMC	1x 10,0x37,0; 1x 11,0x37,0; 1x 12,0x37,0; 1x 13,0x37,0; 1x 14,0x37,0; 1x 15,0x37,0; 1x 16,0x37,0; 1x 17,0x37,0; 1x 18,0x37,0; 1x 19,0x37,0; 1x 20,0x37,0; 1x 21,0x37,0; 1x 22,0x37,0; 1x 24,0x37,0; 1x 27,0x40,0; 1x 30,0x42,0; 1x 32,0x42,0
○	8740 C HF	1x 4,0x60,0; 1x 4,0x140,0; 1x 5,0x60,0; 1x 5,0x140,0; 1x 6,0x60,0; 1x 6,0x140,0; 1x 7,0x60,0; 1x 8,0x60,0; 1x 10,0x60,0
	9822	1x 344,0x30,0x392,0

9730 Depósito de espuma juego de llaves 6000 Joker Set 1



05150120001		
	6000 Joker	1x 8x144; 1x 10x159; 1x 11x165; 1x 12x170,7; 1x 13x177; 1x 14x188; 1x 15x200; 1x 16x212; 1x 17x224; 1x 18x235; 1x 19x246
	9830	1x 172,0x30,0x392,0

9731 Depósito de espuma juego de llaves 6003 Joker Set 1



05150121001		
	6003 Joker	1x 6x105; 1x 7x110; 1x 8x115; 1x 9x120; 1x 10x125; 1x 11x135; 1x 12x148; 1x 13x160; 1x 14x167; 1x 15x174; 1x 16x182; 1x 17x190; 1x 18x210; 1x 19x230,0; 1x 20x230,0; 1x 21x260; 1x 22x260; 1x 24x280
	Abridor de botellas	1x 148
	9831	1x 344,0x30,0x392,0

9732 Depósito de espuma juego de llaves 6004 Joker Set 1



05150122001		
	6004 Joker XS	1x 7-10 (1/4"-3/8")x117
	6004 Joker S	1x 10-13 (7/16"-1/2")x154
	6004 Joker M	1x 13-16 (1/2"-5/8")x188
	6004 Joker L	1x 16-19 (5/8"-3/4")x224
	6004 Joker XL	1x 19-24x (3/4"-15/16")x256
	9832	1x 172,0x30,0x392,0

9740 Depósito de espuma para juegos de llaves acodadas Set 1

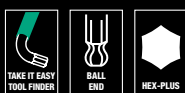

9750 Depósito de espuma juego Kraftform Kompakt y Tool-Check PLUS Set 1



05150150001		
	1x Tool-Check PLUS	
	● 8001 A	1x 1/4"x87,0
	● 813	1x 1/4"x78
	● 889/4/1 K	1x 1/4"x50
	○ 870/1	1x 1/4"x25 ¹⁾
	● 8790 HMA	1x 5.5x23,0; 1x 6.0x23,0; 1x 7.0x23,0; 1x 8.0x23,0; 1x 10.0x23,0; 1x 12.0x23,0; 1x 13.0x23,0
	⊕ 851/1 TZ	2x PH 1x25; 3x PH 2x25; 1x PH 3x25
	⊕ 855/1 TH	1x PZ 1x25; 3x PZ 2x25; 1x PZ 3x25
	⊕ 867/1 TZ TORX®	1x TX 10x25; 1x TX 15x25; 1x TX 20x25; 1x TX 25x25; 1x TX 30x25; 1x TX 40x25
	⊕ 867/1 Z TORX® BO	1x TX 10x25; 1x TX 15x25; 1x TX 20x25; 1x TX 25x25; 1x TX 30x25
	○ 840/1 Z	1x 3.0x25; 1x 4.0x25; 1x 5.0x25; 1x 6.0x25; 1x 8.0x25
	⊖ 800/1 TZ	1x 1.0x5.5x25
	1x Kraftform Kompakt 60	
	● 816 R	1x 1/4"x119
	⊕ 851/4 Z	1x PH 1x89; 1x PH 2x89; 1x PH 3x89 ²⁾
	⊕ 855/4 Z	1x PZ 1x89; 1x PZ 2x89; 1x PZ 3x89 ²⁾
	⊕ 867/4 Z TORX® BO	1x TX 10x89; 1x TX 15x89; 1x TX 20x89; 1x TX 25x89; 1x TX 30x89
	⊖ 800/4 Z	1x 1.0x5.5x89
	○ 840/4 Z	1x 3.0x89; 1x 4.0x89; 1x 5.0x89; 1x 6.0x89 ²⁾
	Cinta autoadhesiva 70	1x 50.0x70.0
	1x 393 S	
	●	1x 1/4"x173,5
	1x 9850	
		1x 172,0x30,0x392,0

¹⁾ Con bola; para llaves de vaso de uso manual

²⁾ Varilla hexagonal

9780 Depósito de espuma juego de alicates KNIPEX Set 1



05150180001	
Alicate univer- sal KNIPEX 03 05 180	1x 180
Tenaza para bombas de agua KNIPEX Cobra® 87 05 250	1x 250
Alicate de cor- te diagonal de fuerza KNIPEX 74 05 160	1x 160
9880	1x 172,0x30,0x392,0

9782 Depósito de espuma juego de martillos Set 1

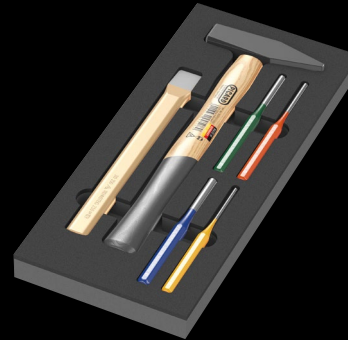

05150182001	
Martillo de cerrajero PICARD® de 500 g, 0000101-500	1x 500,0
Punzones de chaveta exclusive de RENNSTEIG	1x 452 003 6 RC, 3,0x150; 1x4520046RC, 4,0x150; 1x4520066RC, 6,0x150; 1x 452 008 6 RC, 8,0x150
Cinzel plano de RENNSTEIG 310 250 1	1x 25,0x13,0x23,0
9882	1x 172,0x30,0x392,0

9783 Depósito de espuma juego de limas de PFERD Set 1

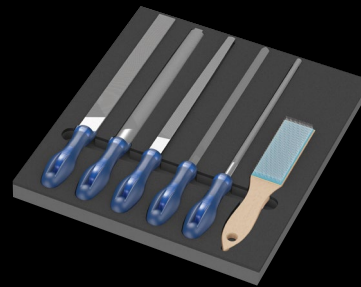

05150183001	
Lima de taller cuadrada, de PFERD PF1142 250 H2	1x 250
Lima de taller de media caña-punta, de PFERD 1152SP 250 H2	1x 250
Lima de taller redonda, de PFERD 1162 250 H2	1x 250
Lima de taller plana parale- la, de PFERD 1112 250 H2	1x 250
Lima de taller triangular, de PFERD 1132 250 H2	1x 250
Cepillo para limas, de PFERD HBF alambre de acero Ø 0,15	1x 232
9883	1x 344,0x30,0x392,0

9781 Depósito de espuma juego de alicates KNIPEX Set 2

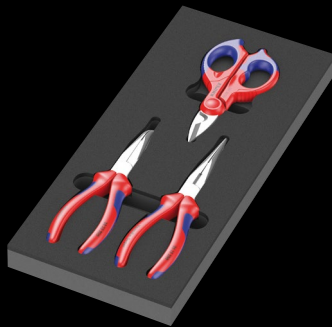

05150181001	
Alicate de montaje (Alicate de boca cigüeña) KNIPEX 26 15 200	1x 200
Alicate para mecánicos KNIPEX 38 25 200	1x 200
Tijeras para electricistas KNIPEX 95 05 155	1x 155
9881	1x 172,0x30,0x392,0

Nos reservamos el derecho de modificar – sin previo aviso y en cualquier momento – todos los datos sobre las características de productos, las variantes y las versiones que se mencionan en este catálogo. Queda excluida la responsabilidad por errores de imprenta o por equivocaciones.



Wera Tools Ibérica, S.L.
Avda. Corts Catalanes 2, Local 5
E - 08173 Sant Cugat del Vallès
(Barcelona)
Tel +34 93 7297240
ventas@weraspain.com

Wera Werkzeuge GmbH
Korzerter Straße 21–25
D-42349 Wuppertal

Tel +49 (0)202/40 45-0
info@wera.de

www.wera.de



ES 05 510263 024 - 0053701 - 01