

Työkaluvaunu ja vaahtomuovisisukset

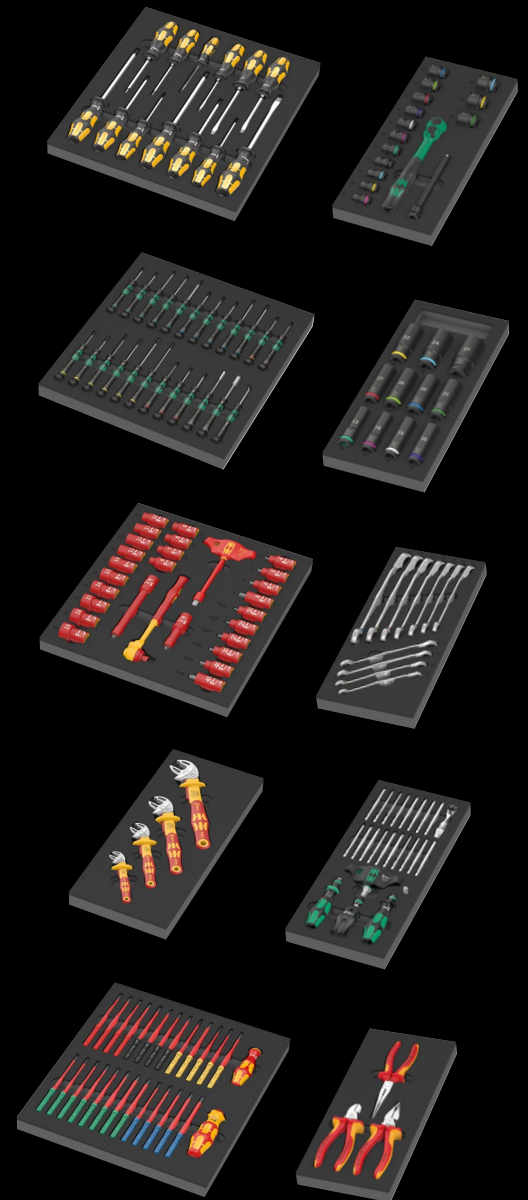

Huippulaadukas työkaluvaunu sisältäen työkalut ja upean ilmeen.

- Ylellinen Tool Rebel -muotoiltu työkaluvaunu
- Erittäin kestävä tuplaseinärakenteen ansiosta
- 7 laatikkoa (5 matalaa, 2 korkeaa), joista 2 matalaa laatikkoa sisältävät työkalusarjat vaahtomuovisisuksissa
- Matalien laatikoiden mitat (leveys x korkeus x syvyys): 522 x 81 x 398 mm
- Korkeiden laatikoiden mitat (leveys x korkeus x syvyys): 522 x 166 x 398 mm
- 100-prosenttinen laatikoiden ulosveto kuulalaakeroiduilla teleskooppikiskoilla, automaattinen sulkeutuminen
- Kaikissa laatikoissa on huolella asennettu kalvopäällyste
- Alhainen riski vaunun kaatumiselle laatikkolukituksen ansiosta. Vain yksi laatikko voidaan avata kerrallaan, ei useaa yhtäaikaisesti avattua laatikkoa
- Korkealaatuiset, pitkäikäiset vaahtomuovisisukset ilman haihtuvia kemiallisia aineita
- Ihanteellinen sovitus helpottaa työkalujen ottamista vaahtomuovisisuksesta





9700 Tool Rebel -työkaluvaunu 1



Sisältää seuraavat vaahtomuovisisukset:

9710



9720

1/4"

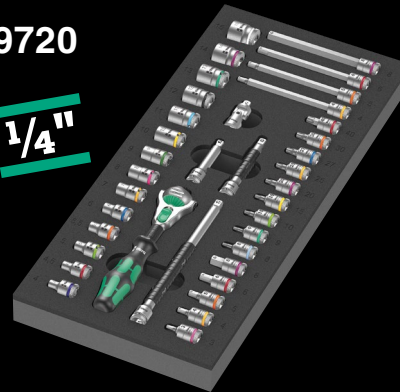

9731



9740



Upea Tool Rebel -työkaluvaunu Tool Rebel designilla. 5 matalaa ja 2 korkeaa laatikkoa takaa työkalujen ja materiaalien tehokkaan ja liikkuvan järjestelyn. Tuplaseinät ja ympäri hitsattu rakenne tekevät koko rungosta erittäin tukevan. Päivittäiseen kovaan korjaamokäyttöön. Sisältää neljä Wera-vaahtomuovisisusta: 9710 vaahtomuovisisus ruuvitalat Set 1, 9720 vaahtomuovisisus 8000 A Zyklop-räikkä Set 1, 9731 vaahtomuovisisus 6003 Joker-lenkkiavain Set 1, 9740 vaahtomuovisisus L-avain Set 1.

05150130001 1x 9700 Tool Rebel -työkaluvaunu 1

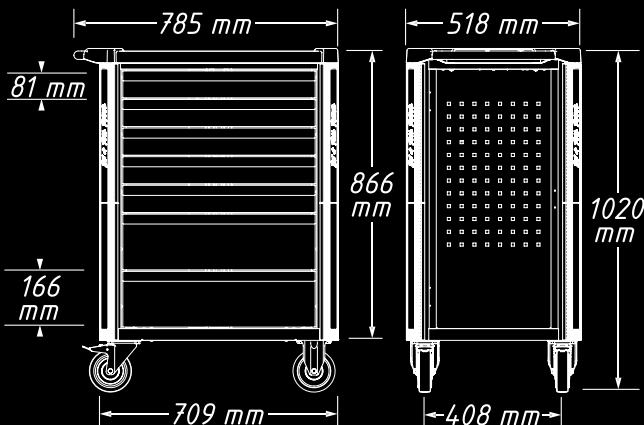

UUSI

9714 vaahtomuovisisus lyötävät ruuvitalttat Set 1

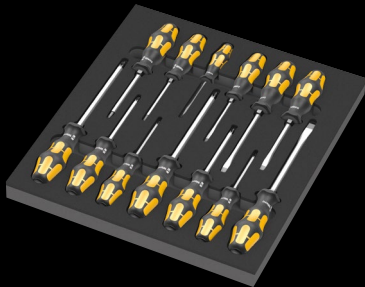

05150105001		
+	917 SPH	1x PH 1x80; 1x PH 2x100; 1x PH 3x150
+	918 SPZ	1x PZ 1x80; 1x PZ 2x100; 1x PZ 3x150
-	932 A	1x 0,6x3,5x80 ¹⁾ ; 1x 0,8x4,5x90; 1x 1,0x5,5x100; 1x 1,2x7,0x125; 1x 1,6x9,0x150
+	977 TORX®	1x TX 20x90; 1x TX 25x100
	9814	1x 344,0x30,0x392,0

¹⁾ Ei kahvan läpi kulkevaa terää, iskuhattua eikä työkalusovitinta

UUSI

9715 vaahtomuovisisus ruuvitalttat Kraftform Micro Set 1

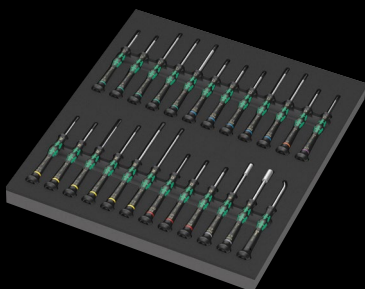

05150106001		
+	2050 Micro	1x PH 000x40 ^{1) 2)} ; 1x PH 00x40 ^{1) 2)} ; 1x PH 0x40 ³⁾
+	2067 TORX® HF	1x TX 5x40; 1x TX 6x40; 1x TX 7x60; 1x TX 8x60; 1x TX 10x60
+	2067 TORX PLUS® IPR Micro	1x 1 IPRx40 ⁴⁾
+	2072 Micro	1x mx40
○	2054 Micro	1x 0,7x40; 1x 0,9x40; 1x 1,3x40; 1x 1,5x60; 1x 2x60
-	2035 Micro	1x 0,23x1,5x40; 1x 0,30x1,8x60; 1x 0,35x2,5x40; 1x 0,40x2,0x60; 1x 0,40x2,5x80; 1x 0,50x3,0x80
●	2069 Micro	1x 4,0x60; 1x 5,5x60
●	1429	1x 1,0x3,5x50
	9815	1x 344,0x30,0x392,0

¹⁾ Optimoitu japanilaisille PH-ruuveille

²⁾ Terä on sorvattu kärjen päästä 10 mm:n pituudelta nimellismittaan

³⁾ Koko 0 muutettu standardin JICIS 0 (Japanese Camera Industrial Standard) mukaiseksi

⁴⁾ Ilman reikää

UUSI

9726 vaahtomuovisisus 8007 B VDE Zyklop -räikkä Set 1, 3/8"

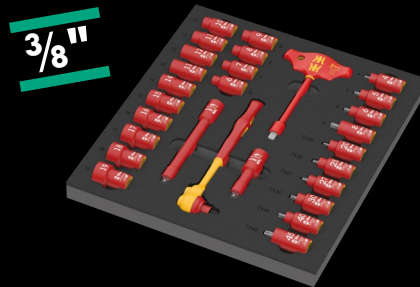

05150116001		
○	8007 B VDE	1x 3/8"x222,0
○	410 i VDE B	1x 3/8"x130
●	8790 B VDE	1x 6,0x46,0; 1x 7,0x46,0; 1x 8,0x46,0; 1x 9,0x46,0; 1x 10,0x46,0; 1x 11,0x46,0; 1x 12,0x46,0; 1x 13,0x46,0; 1x 14,0x46,0; 1x 15,0x46,0; 1x 16,0x46,0; 1x 17,0x46,0; 1x 18,0x46,0; 1x 19,0x46,0
+	8767 B VDE HF	1x TX 20x55,0; 1x TX 25x55,0; 1x TX 27x55,0; 1x TX 30x55,0; 1x TX 40x55,0; 1x TX 45x59,0
○	8740 B VDE HF	1x 4,0x55,0; 1x 5,0x55,0; 1x 6,0x55,0; 1x 8,0x59,0
○	8794 SB VDE	1x 3/8"x91,0
○	8794 LB VDE	1x 3/8"x166,0
	9826	1x 344,0x30,0x392,0

UUSI

9734 vaahtomuovisisus 6004 Joker VDE Set 1



05150124001		
	6004 Joker VDE XS	1x 7-10 (1/4"-3/8")x119
	6004 Joker VDE S	1x 10-13 (7/16"-1/2")x155
	6004 Joker VDE M	1x 13-16 (1/2"-5/8")x190
	6004 Joker VDE L	1x 16-19 (5/8"-3/4")x226
	9834	1x 172,0x30,0x392,0

Huomaa: vaahtomuovisisukset eivät sovi työkaluvaunun edeltävään malliin 05501051001.

UUSI

9751 vaahtomuovisisus Kraftform Kompakt VDE Set 1

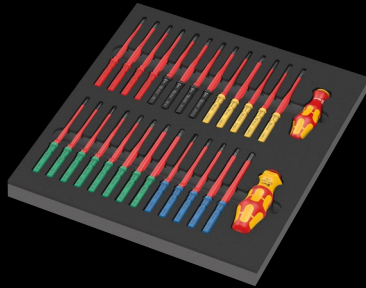

05150151001		
●	837 i RA	1x 9x115
●	817 VDE	1x 9x98
⊕	Kraftform Kompakt VDE 62 iS Take it easy	1x PH 1x157; 1x PH 2x157
⊕	Kraftform Kompakt VDE 65 iS Take it easy	1x PZ 1x157; 1x PZ 2x157
⊕	Kraftform Kompakt VDE 62 iS PH/S Take it easy	1x # 1x157; 1x # 2x157
⊕	Kraftform Kompakt VDE 65 iS PZ/S Take it easy	1x # 1x157; 1x # 2x157
⊕	Kraftform Kompakt VDE 67 i Take it easy	1x TX 8x157; 1x TX 9x157; 1x TX 10x157; 1x TX 27x157; 1x TX 30x157
⊕	Kraftform Kompakt VDE 67 iS Take it easy	1x TX 15x157; 1x TX 20x157; 1x TX 25x157
○	Kraftform Kompakt VDE 64 i Take it easy	1x 2,5x157; 1x 3,0x157; 1x 4,0x157; 1x 5,0x157; 1x 6,0x157
⊖	Kraftform Kompakt VDE 60 iS Take it easy	1x 0,6x3,5x157; 1x 0,8x4,0x157; 1x 1,0x5,5x157
⊖	Kraftform Kompakt VDE 60 i Take it easy	1x 0,4x2,5x157; 1x 1,2x6,5x157
	9851	1x 344,0x30,0x392,0

UUSI

9724 vaahtomuovisisus 8010 B Zyklop Comfort -räikkä Set 1, 3/8"



3/8"



05150114001		
○	8010 B	1x 3/8"x230,0
●	8790 B Impaktor	1x 8,0x30,0; 1x 10,0x30,0; 1x 11,0x30,0; 1x 12,0x30,0; 1x 13,0x30,0; 1x 14,0x30,0; 1x 15,0x30,0; 1x 16,0x30,0; 1x 17,0x30,0; 1x 18,0x30,0; 1x 19,0x30,0; 1x 21,0x32,0; 1x 22,0x32,0; 1x 24,0x32,0
●○	8798 B	1x 3/8"x152,4
	9824	1x 172,0x30,0x392,0

UUSI

9725 vaahtomuovisisus Zyklop C, 1/2", Impaktor Deep -hylsy Set 1



05150115001		
●	8790 C Impaktor Deep	1x 13,0x83,0; 1x 14,0x83,0; 1x 15,0x83,0; 1x 16,0x83,0; 1x 17,0x83,0; 1x 18,0x83,0; 1x 19,0x83,0; 1x 21,0x83,0; 1x 22,0x83,0; 1x 24,0x83,0; 1x 27,0x83,0
	9825	1x 172,0x30,0x392,0

UUSI

9733 vaahтомуovisisus 6001 Joker Switch Set 1

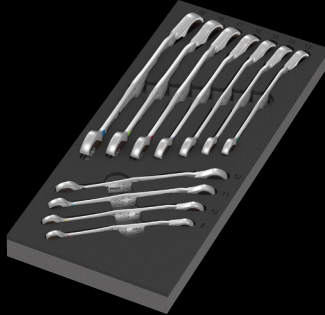

05150123001	
	6001 Joker Switch 1x 8x144; 1x 10x159; 1x 11x165; 1x 12x171; 1x 13x179; 1x 14x187; 1x 15x199; 1x 16x213; 1x 17x225; 1x 18x234; 1x 19x246
	9833 1x 172,0x30,0x392,0

UUSI

9784 vaahтомуovisisus KNIPEX-pihdit VDE Set 1

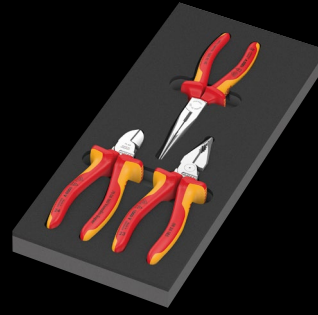

05150184001	
	KNIPEX-sivuleikkurit 70 06 160
	KNIPEX-lattapyöröpihti, jossa terä (pantografipihti) 26 16 200
	KNIPEX-yhdistelmäpihdit 08 26 185
	9884 1x 172,0x30,0x392,0

UUSI

9752 vaahтомуovisisus Krafftform Kompakt -räikät Set 1



1/4"

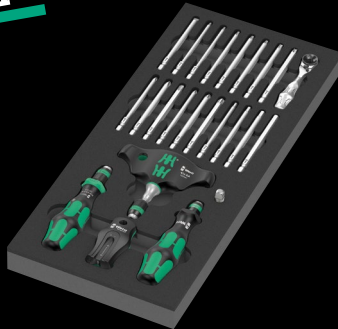

05150152001	
●	838 RA-R M 1x 1/4"x123,5
●	416 RA 1x 1/4"x45
●	816 R 1x 1/4"x119
●	8001 A 1x 1/4"x87,0
⊕	851/4 Z 1x PH 1x89; 1x PH 2x89; 1x PH 3x89 ¹⁾
⊕	855/4 Z 1x PZ 1x89; 1x PZ 2x89; 1x PZ 3x89 ¹⁾
⊕	867/4 Z TORX® 1x TX 10x89; 1x TX 15x89; 1x TX 20x89; 1x TX 25x89; 1x TX 27x89; 1x TX 30x89; 1x TX 40x89
○	840/4 Z 1x 3,0x89; 1x 4,0x89; 1x 5,0x89; 1x 6,0x89 ¹⁾
⊖	800/4 Z 1x 1,0x5,5x89
○	870/1 1x 1/4"x25 ²⁾
	9500 1x 64,6
	9852 1x 172,0x30,0x392,0

¹⁾ Kuusikulmainen terä

²⁾ Kuulalukituksella; käsikäyttöisille hylsille

9710 vaahтомуovisisus ruuvitaltat Set 1



05150101001	
⊖	932 A 1x 1,0x5,5x100; 1x 1,2x7,0x125
⊕	350 PH 1x PH 1x80; 1x PH 2x100; 1x PH 3x150
⊕	350 PH Stubby 1x PH 2x25
⊕	355 PZ 1x PZ 1x80; 1x PZ 2x100
⊖	335 1x 0,8x4,0x100; 1x 1,0x5,5x125
⊖	334 1x 1,2x6,5x150
⊖	335 Stubby/ kaasutinruuvitaltta 1x 1,0x5,5x24,5
⊕	2050 Micro 1x PH 0x40 ¹⁾
⊖	2035 Micro 1x 0,40x2,5x80
⊖	160 i VDE 1x 0,4x2,5x80 ²⁾ ; 1x 0,6x3,5x100 ²⁾
	1441 1x 4,5-6,0x41,0
	1442 1x 6,0-8,5x41,0
	9810 1x 344,0x30,0x392,0

¹⁾ Koko 0 muutettu standardin JCS 0 (Japanese Camera Industrial Standard) mukaiseksi

²⁾ ei Lasertip-kärkeä

9711 vaahtomuovisisus VDE-ruuvitaltat Set 1

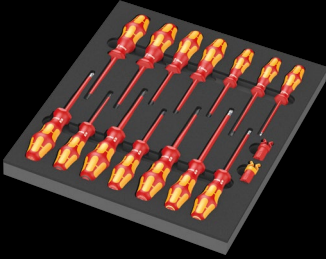

05150102001	
+	162 iS PH VDE 1x PH 1x80; 1x PH 2x100
+	165 iS PZ VDE 1x PZ 1x80; 1x PZ 2x100
+	165 i PZ/S VDE 1x # 2x100
-	160 i VDE 1x 0,4x2,5x80 ¹⁾ ; 1x 0,8x4,0x100; 1x 1,0x5,5x125
-	160 iS VDE 1x 0,6x3,5x100
+	167 i TORX® VDE 1x TX 10x80; 1x TX 15x80; 1x TX 20x80; 1x TX 25x100; 1x TX 30x100
	1440 1x 4,5-6,0x41,0
	1442 1x 6,0-8,5x41,0
	9811 1x 344,0x30,0x392,0

¹⁾ ei Lasertip-kärkeä

9713 vaahtomuovisisus Hex-ruuvitaltat Set 1

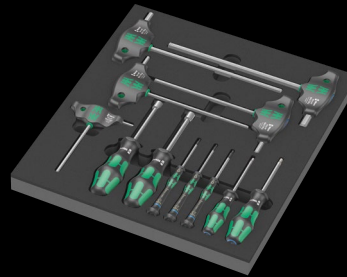

05150104001	
○	354 1x 3,0x75; 1x 4,0x75
○	2054 Micro 1x 1,5x60; 1x 2x60; 1x 2,5x60
○	454 HF 1x 4x100; 1x 5x100; 1x 6x150; 1x 8x200; 1x 10x200
●	395 H0 1x 10,0x90; 1x 13,0x90
	9813 1x 344,0x30,0x392,0

9720 vaahtomuovisisus 8000 A Zyklop -räikkä 1/4" Set 1



9712 vaahtomuovisisus TORX® HF -ruuvitaltat Set 1

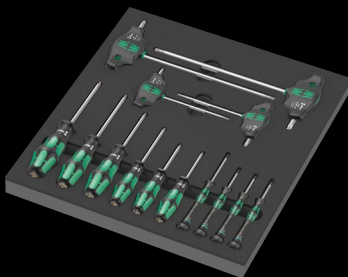
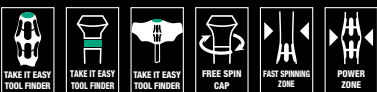

05150103001	
+	367 TORX® HF 1x TX 8x60; 1x TX 9x60; 1x TX 10x80; 1x TX 15x80; 1x TX 20x100; 1x TX 25x100
+	2067 TORX® HF 1x TX 4x40; 1x TX 5x40; 1x TX 6x40; 1x TX 7x60
+	467 TORX® HF 1x TX 20x100; 1x TX 25x100; 1x TX 30x200; 1x TX 40x200
	9812 1x 344,0x30,0x392,0

05150110001	
○	8000 A 1x 1/4"x152,0
●○	8794 LA 1x 1/4"x150,0
●○	8794 SA 1x 1/4"x75,0
●○	8795 A 1x 1/4"x35,5
●○	8794 A 1x 1/4"x56,0
●	8790 HMA 1x 4,0x23,0; 1x 4,5x23,0; 1x 5,0x23,0; 1x 5,5x23,0; 1x 6,0x23,0; 1x 7,0x23,0; 1x 8,0x23,0; 1x 9,0x23,0; 1x 10,0x23,0; 1x 11,0x23,0; 1x 12,0x23,0; 1x 13,0x23,0; 1x 14,0x23,0; 1x 15,0x23,0
+	8767 A HF 1x TX 8x28,0; 1x TX 9x28,0; 1x TX 10x28,0; 1x TX 15x28,0; 1x TX 20x28,0; 1x TX 25x28,0; 1x TX 27x28,0; 1x TX 30x28,0; 1x TX 40x28,0
○	8740 A HF 1x 3,0x28,0; 1x 4,0x28,0; 1x 4,0x100,0; 1x 5,0x28,0; 1x 5,0x100,0; 1x 6,0x28,0; 1x 6,0x100,0; 1x 8,0x28,0; 1x 8,0x100,0
	9820 1x 172,0x30,0x392,0

9721 vaahtomuovisisus 8000 B Zyklus -räikkä 3/8" Set 1



3/8"

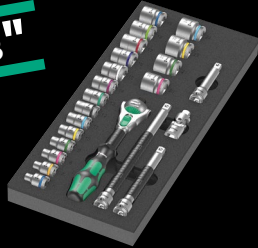

05150111001		
○	8000 B	1x 3/8"x199,0
●○	8794 SB	1x 3/8"x125,0
●○	8794 LB	1x 3/8"x200,0
●○	8795 B	1x 3/8"x50,0
●○	8794 B	1x 3/8"x76,0
●	8790 HMB	1x 6,0x29,0; 1x 7,0x29,0; 1x 8,0x29,0; 1x 9,0x29,0; 1x 10,0x29,0; 1x 11,0x29,0; 1x 12,0x29,0; 1x 13,0x29,0; 1x 14,0x29,0; 1x 15,0x29,0; 1x 16,0x30,0; 1x 17,0x30,0; 1x 18,0x30,0; 1x 19,0x30,0; 1x 20,0x30,0; 1x 21,0x30,0; 1x 22,0x30,0; 1x 24,0x32,0
	9821	1x 172,0x30,0x392,0

9723 vaahtomuovisisus Zyklus B 3/8" -kärkihylsyt Set 1



3/8"



05150113001		
●●	8784 B1	1x 1/4"x3/8"x44,0
⊗	8767 B HF	1x TX 15x35,0; 1x TX 20x35,0; 1x TX 25x35,0; 1x TX 25x107,0; 1x TX 27x35,0; 1x TX 27x107,0; 1x TX 30x35,0; 1x TX 30x107,0; 1x TX 40x35,0; 1x TX 40x107,0
○	8740 B HF	1x 4,0x35,0; 1x 4,0x107,0; 1x 5,0x35,0; 1x 5,0x107,0; 1x 6,0x35,0; 1x 6,0x107,0; 1x 7,0x38,5; 1x 8,0x38,5; 1x 8,0x100,0; 1x 10,0x38,5; 1x 10,0x100,0
	9823	1x 172,0x30,0x392,0

9722 vaahtomuovisisus 8000 C Zyklus 1/2" -räikkä Set 1



1/2"



05150112001		
○	8000 C	1x 1/2"x277,0
●○	8794 LC	1x 1/2"x250,0
●○	8794 SC	1x 1/2"x125,0
●○	8795 C	1x 1/2"x69,0
●○	8794 C	1x 1/2"x52,0
●	8790 HMC	1x 10,0x37,0; 1x 11,0x37,0; 1x 12,0x37,0; 1x 13,0x37,0; 1x 14,0x37,0; 1x 15,0x37,0; 1x 16,0x37,0; 1x 17,0x37,0; 1x 18,0x37,0; 1x 19,0x37,0; 1x 20,0x37,0; 1x 21,0x37,0; 1x 22,0x37,0; 1x 24,0x37,0; 1x 27,0x40,0; 1x 30,0x42,0; 1x 32,0x42,0
○	8740 C HF	1x 4,0x60,0; 1x 4,0x140,0; 1x 5,0x60,0; 1x 5,0x140,0; 1x 6,0x60,0; 1x 6,0x140,0; 1x 7,0x60,0; 1x 8,0x60,0; 1x 10,0x60,0
	9822	1x 344,0x30,0x392,0

9730 vaahtomuovisisus 6000 Joker Set 1



05150120001		
	6000 Joker	1x 8x144; 1x 10x159; 1x 11x165; 1x 12x170,7; 1x 13x177; 1x 14x188; 1x 15x200; 1x 16x212; 1x 17x224; 1x 18x235; 1x 19x246
	9830	1x 172,0x30,0x392,0

9731 vaahantuovivisus 6003 Joker Set 1



05150121001		
	6003 Joker	1x 6x105; 1x 7x110; 1x 8x115; 1x 9x120; 1x 10x125; 1x 11x135; 1x 12x148; 1x 13x160; 1x 14x167; 1x 15x174; 1x 16x182; 1x 17x190; 1x 18x210; 1x 19x230,0; 1x 20x230,0; 1x 21x260; 1x 22x260; 1x 24x280
	Pullonavaaja	1x 148
	9831	1x 344,0x30,0x392,0

9732 vaahantuovivisus 6004 Joker Set 1



05150122001		
	6004 Joker XS	1x 7-10 (1/4"-3/8")x117
	6004 Joker S	1x 10-13 (7/16"-1/2")x154
	6004 Joker M	1x 13-16 (1/2"-5/8")x188
	6004 Joker L	1x 16-19 (5/8"-3/4")x224
	6004 Joker XL	1x 19-24x (3/4"-15/16")x256
	9832	1x 172,0x30,0x392,0

9740 vaahantuovivisus L-avaimet Set 1



Huomaa: vaahantuovivisukset eivät sovi työkaluvaunun edeltävään malliin 05501051001.

9750 vaahantuovivisus Kraffform Kompakt ja Tool-Check PLUS Set 1



05150150001		
	1x Tool-Check PLUS	
	● 8001 A	1x 1/4"x87.0
	● 813	1x 1/4"x78
	● 889/4/1 K	1x 1/4"x50
	○ 870/1	1x 1/4"x25 ¹⁾
	● 8790 HMA	1x 5.5x23.0; 1x 6.0x23.0; 1x 7.0x23.0; 1x 8.0x23.0; 1x 10.0x23.0; 1x 12.0x23.0; 1x 13.0x23.0
	⊕ 851/1 TZ	2x PH 1x25; 3x PH 2x25; 1x PH 3x25
	⊕ 855/1 TH	1x PZ 1x25; 3x PZ 2x25; 1x PZ 3x25
	⊕ 867/1 TZ TORX®	1x TX 10x25; 1x TX 15x25; 1x TX 20x25; 1x TX 25x25; 1x TX 30x25; 1x TX 40x25
	⊕ 867/1 Z TORX® BO	1x TX 10x25; 1x TX 15x25; 1x TX 20x25; 1x TX 25x25; 1x TX 30x25
	○ 840/1 Z	1x 3.0x25; 1x 4.0x25; 1x 5.0x25; 1x 6.0x25; 1x 8.0x25
	⊖ 800/1 TZ	1x 1.0x5.5x25
	1x Kraffform Kompakt 60	
	● 816 R	1x 1/4"x119
	⊕ 851/4 Z	1x PH 1x89; 1x PH 2x89; 1x PH 3x89 ²⁾
	⊕ 855/4 Z	1x PZ 1x89; 1x PZ 2x89; 1x PZ 3x89 ²⁾
	⊕ 867/4 Z TORX® BO	1x TX 10x89; 1x TX 15x89; 1x TX 20x89; 1x TX 25x89; 1x TX 30x89
	⊖ 800/4 Z	1x 1.0x5.5x89
	○ 840/4 Z	1x 3.0x89; 1x 4.0x89; 1x 5.0x89; 1x 6.0x89 ²⁾
	Tarranauha 70	1x 50.0x70.0
	1x 393 S	
	●	1x 1/4"x173,5
	1x 9850	
		1x 172,0x30,0x392,0

¹⁾ Kuulalukituksella; käsikäyttöisille hylsille

²⁾ Kuusikulmainen terä

05150140001		
	1x 950/9 Hex-Plus Multicolour 1	
	○ 950 SPKL Multicolour	1x 1.5x90; 1x 2.0x101; 1x 2.5x112; 1x 3.0x123; 1x 4.0x137; 1x 5.0x154; 1x 6.0x172; 1x 8.0x195; 1x 10.0x224
	1x 967/9 TX XL Multicolour 1	
	⊕ 967 SXL TORX® Multicolour	1x TX 8x90; 1x TX 9x101; 1x TX 10x112
	⊕ 967 SPKXL TORX® Multicolour	1x TX 15x123; 1x TX 20x137; 1x TX 25x154; 1x TX 27x172; 1x TX 30x195; 1x TX 40x224
	1x 9500	
		1x 64,6
	1x STABILA® taskumittanauha MB 100, 3 m, tuote 19570	
		1x 3000,0
	1x 9840	
		1x 172,0x30,0x392,0

9780 vaahtomuovisisus KNIPEX-pihdit Set 1



05150180001		
	KNIPEX-yhdistelmäpihdit 03 05 180	1x 180
	KNIPEX Cobra® Hightech -vesipumppu-pihdit 87 05 250	1x 250
	KNIPEX-voimasivuleikkurit 74 05 160	1x 160
9880		1x 172,0x30,0x392,0

9782 vaahtomuovisisus vasarat Set 1

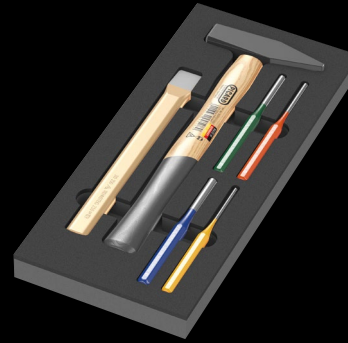

05150182001		
	PICARD®-pajavasara 500 g, 0000101-500	1x 500,0
	RENNSTEIG tuurna	1x 452 003 6 RC, 3,0x150;
	Exklusiv	1x 452 008 6 RC, 8,0x150
	RENNSTEIG litteä taltta 310 250 1	1x 25,0x13,0x23,0
9882		1x 172,0x30,0x392,0

9781 vaahtomuovisisus KNIPEX-pihdit Set 2

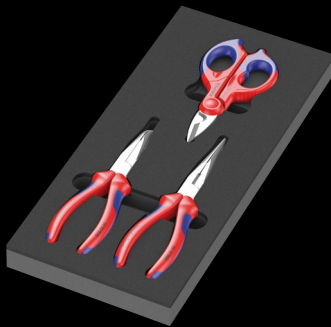

05150181001		
	KNIPEX-latapyöröpihdit terällä (pantografipihditi) 26 16 200	1x 200
	KNIPEX -asentajan pihdit 38 25 200	1x 200
	KNIPEX-sähköasentajan sakset 95 05 155	1x 155
9881		1x 172,0x30,0x392,0

9783 vaahtomuovisisus PFERD-viilat Set 1

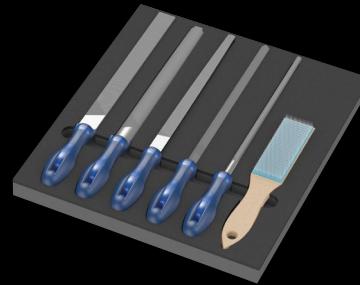

05150183001		
	PFERD-korjaamoviila neliö PF1142 250 H2	1x 250
	PFERD-korjaamoviila puolipyöreä-terävä 1152SP 250 H2	1x 250
	PFERD-korjaamoviila pyöreä 1162 250 H2	1x 250
	PFERD-korjaamoviila litteätynkä 1112 250 H2	1x 250
	PFERD-korjaamoviila kolmio 1132 250 H2	1x 250
	PFERD-viilaharja HBF teräslanka Ø 0,15	1x 232
9883		1x 344,0x30,0x392,0

Pidätämme oikeuden muuttaa kaikkia tämän lehden sisältämiä tietoja, mukaan lukien tuotteen ominaisuuksista, versioista ja malleista, milloin tahansa ilman erillistä ilmoitusta. Emme vastaa mahdollisista paino-, tai tulostusvirheistä.



Wera Tools Finland Oy
Vanha Kaarelantie 33 A
01610 Vantaa

+358 45 206 9556
E-Mail: ahokas@wera.de

Wera Werkzeuge GmbH
Korzarter Straße 21-25
D-42349 Wuppertal

Phone: +49 (0)202/4045-0
E-Mail: info@wera.de

www.wera.de