

Servante d'atelier et inserts en mousse

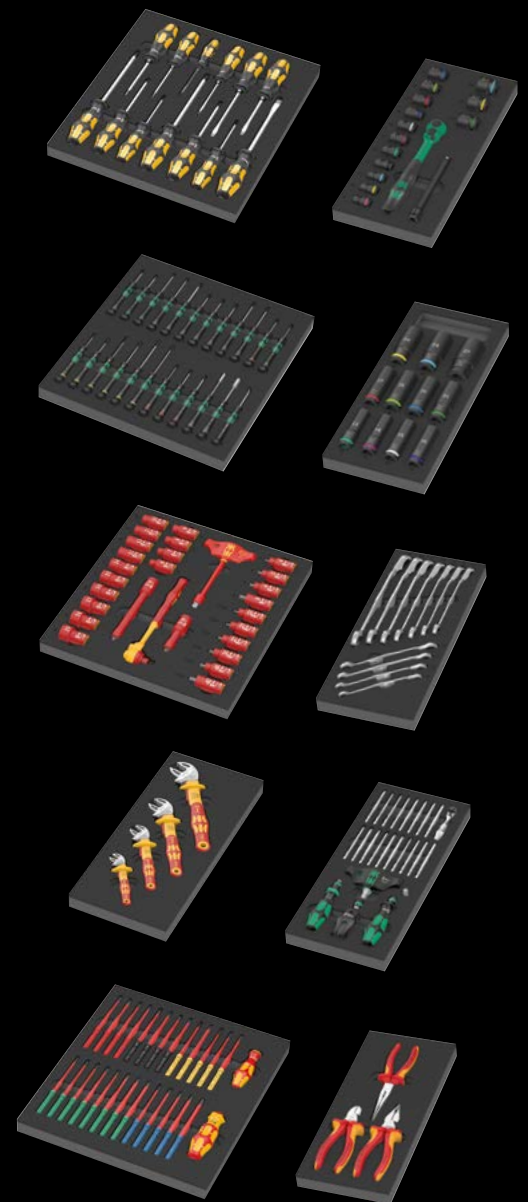

Servante d'atelier équipée, avec façade au design ingénieux en qualité haut de gamme.

- Servante d'atelier exclusive au design Tool Rebel
- Conception extrêmement robuste avec double paroi
- Avec 7 tiroirs (5 plats, 2 hauts), dont 2 tiroirs plats contenant des inserts en mousse et des outils
- Dimensions des tiroirs plats (largeur x hauteur x profondeur) : 522 x 81 x 398 mm
- Dimensions des tiroirs hauts (largeur x hauteur x profondeur) : 522 x 166 x 398 mm
- Ouverture à 100 % des tiroirs avec rails télescopiques à roulement à billes, fermeture autonome
- Tous les tiroirs sont minutieusement placés individuellement
- Risque de basculement réduit grâce au dispositif de blocage qui empêche l'ouverture de plusieurs tiroirs à la fois
- Inserts en mousse haut de gamme durables sans vapeurs chimiques
- Ajustement optimal pour faciliter au maximum le retrait des outils des inserts en mousse





Servante d'atelier 9700 Tool Rebel 1



Servante d'atelier exclusive au design Tool Rebel. 5 tiroirs plats et 2 tiroirs hauts offrent un rangement efficace et mobile des outils et du matériel. Conception extrêmement robuste avec sa double paroi et l'assemblage entièrement soudé de tout le corps. Pour le quotidien exigeant du travail en atelier. Équipée de 4 inserts en mousse Wera : 9710 insert en mousse pour jeu de tournevis 1, 9720 insert en mousse pour jeu de cliquets 8000 A Zyklop 1, 9731 insert en mousse pour jeu de clés mixtes 6003 Joker 1, 9740 insert en mousse pour jeu de clés coudées 1.

05150130001 1x 9700 Servante d'atelier Tool Rebel 1

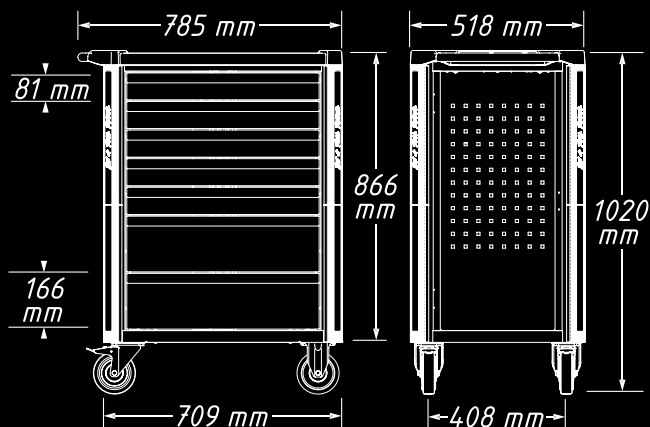

Comprend les inserts en mousse suivants :

9710



9720

1/4"

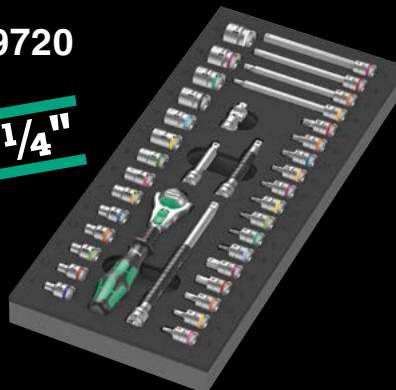

9731



9740



NOUVEAU

Insert en mousse 9714 jeu de tournevis-burins 1



05150105001		
+	917 SPH	1x PH 1x80; 1x PH 2x100; 1x PH 3x150
+	918 SPZ	1x PZ 1x80; 1x PZ 2x100; 1x PZ 3x150
-	932 A	1x 0,6x3,5x80 ¹⁾ ; 1x 0,8x4,5x90; 1x 1,0x5,5x100; 1x 1,2x7,0x125; 1x 1,6x9,0x150
+	977 TORX®	1x TX 20x90; 1x TX 25x100
	9814	1x 344,0x30,0x392,0

¹⁾ Sans lame traversante, heurtoir et plot pour clé

NOUVEAU

Insert en mousse 9715 jeu de tournevis Kraftform Micro 1

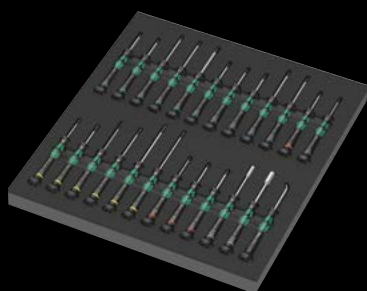

05150106001		
+	2050 Micro	1x PH 000x40 ^{1) 2)} ; 1x PH 00x40 ^{1) 2)} ; 1x PH 0x40 ³⁾
+	2067 TORX® HF	1x TX 5x40; 1x TX 6x40; 1x TX 7x60; 1x TX 8x60; 1x TX 10x60
+	2067 TORX PLUS® IPR Micro	1x 1 IPRx40 ⁴⁾
+	2072 Micro	1x mx40
○	2054 Micro	1x 0,7x40; 1x 0,9x40; 1x 1,3x40; 1x 1,5x60; 1x 2x60
-	2035 Micro	1x 0,23x1,5x40; 1x 0,30x1,8x60; 1x 0,35x2,5x40; 1x 0,40x2,0x60; 1x 0,40x2,5x80; 1x 0,50x3,0x80
●	2069 Micro	1x 4,0x60; 1x 5,5x60
●	1429	1x 1,0x3,5x50
	9815	1x 344,0x30,0x392,0

¹⁾ Optimisées pour les vis PH asiatiques

²⁾ Lame détournée au nominal sur 10 mm

³⁾ Calibre 0 modifié conformément à JCIS 0 (Japanese Camera Industrial Standard)

⁴⁾ Sans perforation

NOUVEAU

Insert en mousse 9726 jeu de cliquet 8007 B VDE Zyklop VDE 1, 3/8"



05150116001		
○	8007 B VDE	1x 3/8"x222,0
○	410 i VDE B	1x 3/8"x130
●	8790 B VDE	1x 6,0x46,0; 1x 7,0x46,0; 1x 8,0x46,0; 1x 9,0x46,0; 1x 10,0x46,0; 1x 11,0x46,0; 1x 12,0x46,0; 1x 13,0x46,0; 1x 14,0x46,0; 1x 15,0x46,0; 1x 16,0x46,0; 1x 17,0x46,0; 1x 18,0x46,0; 1x 19,0x46,0
+	8767 B VDE HF	1x TX 20x55,0; 1x TX 25x55,0; 1x TX 27x55,0; 1x TX 30x55,0; 1x TX 40x55,0; 1x TX 45x59,0
○	8740 B VDE HF	1x 4,0x55,0; 1x 5,0x55,0; 1x 6,0x55,0; 1x 8,0x59,0
○	8794 SB VDE	1x 3/8"x91,0
○	8794 LB VDE	1x 3/8"x166,0
	9826	1x 344,0x30,0x392,0

NOUVEAU

Insert en mousse 9734 jeu 6004 Joker VDE 1



05150124001		
	6004 Joker VDE XS	1x 7-10 (1/4"-3/8")x119
	6004 Joker VDE S	1x 10-13 (7/16"-1/2")x155
	6004 Joker VDE M	1x 13-16 (1/2"-5/8")x190
	6004 Joker VDE L	1x 16-19 (5/8"-3/4")x226
	9834	1x 172,0x30,0x392,0

Attention : les inserts en mousse ne sont pas compatibles avec le modèle précédent 05501051001 de la servante d'atelier.

NOUVEAU

Insert en mousse 9751 jeu Kraftform Kompakt VDE 1

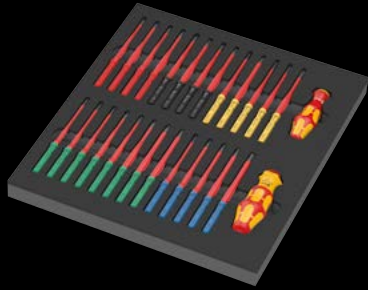

05150151001		
●	837 i RA	1x 9x115
●	817 VDE	1x 9x98
⊕	Kraftform Kompakt VDE 62 iS Take it easy	1x PH 1x157; 1x PH 2x157
⊕	Kraftform Kompakt VDE 65 iS Take it easy	1x PZ 1x157; 1x PZ 2x157
⊕	Kraftform Kompakt VDE 62 iS PH/S Take it easy	1x # 1x157; 1x # 2x157
⊕	Kraftform Kompakt VDE 65 iS PZ/S Take it easy	1x # 1x157; 1x # 2x157
⊕	Kraftform Kompakt VDE 67 i Take it easy	1x TX 8x157; 1x TX 9x157; 1x TX 10x157; 1x TX 27x157; 1x TX 30x157
⊕	Kraftform Kompakt VDE 67 iS Take it easy	1x TX 15x157; 1x TX 20x157; 1x TX 25x157
○	Kraftform Kompakt VDE 64 i Take it easy	1x 2,5x157; 1x 3,0x157; 1x 4,0x157; 1x 5,0x157; 1x 6,0x157
⊖	Kraftform Kompakt VDE 60 iS Take it easy	1x 0,6x3,5x157; 1x 0,8x4,0x157; 1x 1,0x5,5x157
⊖	Kraftform Kompakt VDE 60 i Take it easy	1x 0,4x2,5x157; 1x 1,2x6,5x157
	9851	1x 344,0x30,0x392,0

NOUVEAU

Insert en mousse 9724 jeu de cliquet 8010 B Zyklop Comfort 1, 3/8"



05150114001		
○	8010 B	1x 3/8"x230,0
●	8790 B Impaktor	1x 8,0x30,0; 1x 10,0x30,0; 1x 11,0x30,0; 1x 12,0x30,0; 1x 13,0x30,0; 1x 14,0x30,0; 1x 15,0x30,0; 1x 16,0x30,0; 1x 17,0x30,0; 1x 18,0x30,0; 1x 19,0x30,0; 1x 21,0x32,0; 1x 22,0x32,0; 1x 24,0x32,0
●○	8798 B	1x 3/8"x152,4
	9824	1x 172,0x30,0x392,0

NOUVEAU

Insert en mousse 9725 Zyklop C, 1/2", jeu de douilles Impaktor Deep 1



05150115001		
●	8790 C Impaktor Deep	1x 13,0x83,0; 1x 14,0x83,0; 1x 15,0x83,0; 1x 16,0x83,0; 1x 17,0x83,0; 1x 18,0x83,0; 1x 19,0x83,0; 1x 21,0x83,0; 1x 22,0x83,0; 1x 24,0x83,0; 1x 27,0x83,0
	9825	1x 172,0x30,0x392,0

NOUVEAU

Insert en mousse 9733 jeu 6001 Joker Switch 1

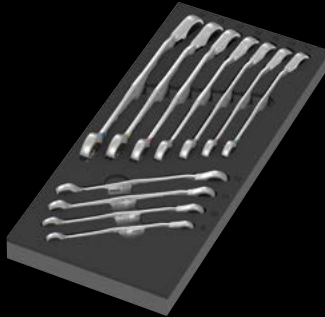

05150123001	
6001 Joker Switch	1x 8x144; 1x 10x159; 1x 11x165; 1x 12x171; 1x 13x179; 1x 14x187; 1x 15x199; 1x 16x213; 1x 17x225; 1x 18x234; 1x 19x246
9833	1x 172,0x30,0x392,0

NOUVEAU

Insert en mousse 9784 jeu de pinces KNIPEX VDE 1



05150184001	
	Pince coupante de côté KNIPEX 70 06 160
	Pince demi-ronde avec tranchant (pince bec de cigogne) KNIPEX 26 16 200
	Pince universelle multifonctions KNIPEX 08 26 185
9884	1x 172,0x30,0x392,0

NOUVEAU

Insert en mousse 9752 jeu Kraftform Kompakt avec fonction cliquet 1



1/4"

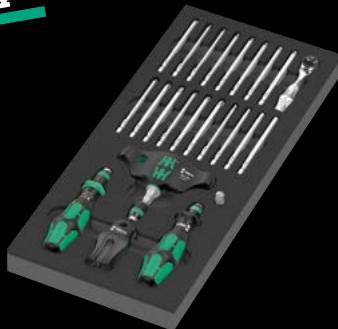

05150152001	
838 RA-R M	1x 1/4"x123,5
416 RA	1x 1/4"x45
816 R	1x 1/4"x119
8001 A	1x 1/4"x87,0
851/4 Z	1x PH 1x89; 1x PH 2x89; 1x PH 3x89 ¹⁾
855/4 Z	1x PZ 1x89; 1x PZ 2x89; 1x PZ 3x89 ¹⁾
867/4 Z TORX®	1x TX 10x89; 1x TX 15x89; 1x TX 20x89; 1x TX 25x89; 1x TX 27x89; 1x TX 30x89; 1x TX 40x89
840/4 Z	1x 3,0x89; 1x 4,0x89; 1x 5,0x89; 1x 6,0x89 ¹⁾
800/4 Z	1x 1,0x5,5x89
870/1	1x 1/4"x25 ²⁾
9500	1x 64,6
9852	1x 172,0x30,0x392,0

Insert en mousse 9710 jeu de tournevis 1



05150101001	
932 A	1x 1,0x5,5x100; 1x 1,2x7,0x125
350 PH	1x PH 1x80; 1x PH 2x100; 1x PH 3x150
350 Tom Pouce PH	1x PH 2x25
355 PZ	1x PZ 1x80; 1x PZ 2x100
335	1x 0,8x4,0x100; 1x 1,0x5,5x125
334	1x 1,2x6,5x150
335 Tournevis Tom Pouce	1x 1,0x5,5x24,5
2050 Micro	1x PH 0x40 ¹⁾
2035 Micro	1x 0,40x2,5x80
160 i VDE	1x 0,4x2,5x80 ²⁾ ; 1x 0,6x3,5x100 ²⁾
1441	1x 4,5-6,0x41,0
1442	1x 6,0-8,5x41,0
9810	1x 344,0x30,0x392,0

¹⁾ Calibre 0 modifié conformément à JCIS 0 (Japanese Camera Industrial Standard)

²⁾ sans Lasertip

¹⁾ Lame hexagonale

²⁾ Avec bille ; pour douilles à carré à actionnement manuel

Insert en mousse 9711 jeu de tournevis VDE 1

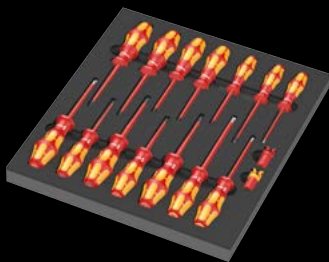

05150102001	
+	162 iS PH VDE 1x PH 1x80; 1x PH 2x100
+	165 iS PZ VDE 1x PZ 1x80; 1x PZ 2x100
+	165 i PZ/S VDE 1x # 2x100
-	160 i VDE 1x 0,4x2,5x80 ¹⁾ ; 1x 0,8x4,0x100; 1x 1,0x5,5x125
-	160 iS VDE 1x 0,6x3,5x100
+	167 i TORX® VDE 1x TX 10x80; 1x TX 15x80; 1x TX 20x80; 1x TX 25x100; 1x TX 30x100
	1440 1x 4,5-6,0x41,0
	1442 1x 6,0-8,5x41,0
	9811 1x 344,0x30,0x392,0

¹⁾ sans Lasertip

Insert en mousse 9713 jeu de tournevis Hex 1

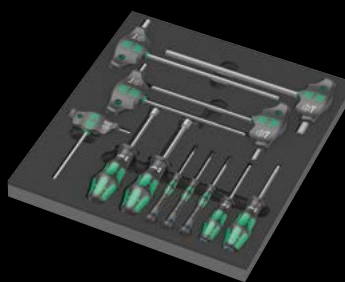

05150104001	
○	354 1x 3,0x75; 1x 4,0x75
○	2054 Micro 1x 1,5x60; 1x 2x60; 1x 2,5x60
○	454 HF 1x 4x100; 1x 5x100; 1x 6x150; 1x 8x200; 1x 10x200
●	395 H0 1x 10,0x90; 1x 13,0x90
	9813 1x 344,0x30,0x392,0

Insert en mousse 9720 jeu de cliquet 8000 A Zyklop 1/4" 1



Insert en mousse 9712 jeu de tournevis TORX® HF 1

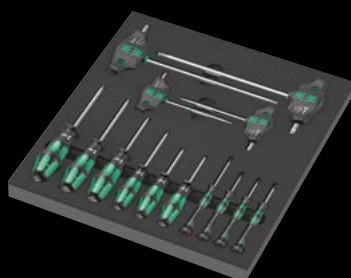

05150103001	
+	367 TORX® HF 1x TX 8x60; 1x TX 9x60; 1x TX 10x80; 1x TX 15x80; 1x TX 20x100; 1x TX 25x100
+	2067 TORX® HF 1x TX 4x40; 1x TX 5x40; 1x TX 6x40; 1x TX 7x60
+	467 TORX® HF 1x TX 20x100; 1x TX 25x100; 1x TX 30x200; 1x TX 40x200
	9812 1x 344,0x30,0x392,0

05150110001	
○	8000 A 1x 1/4"x152,0
●○	8794 LA 1x 1/4"x150,0
●○	8794 SA 1x 1/4"x75,0
●○	8795 A 1x 1/4"x35,5
●○	8794 A 1x 1/4"x56,0
●	8790 HMA 1x 4,0x23,0; 1x 4,5x23,0; 1x 5,0x23,0; 1x 5,5x23,0; 1x 6,0x23,0; 1x 7,0x23,0; 1x 8,0x23,0; 1x 9,0x23,0; 1x 10,0x23,0; 1x 11,0x23,0; 1x 12,0x23,0; 1x 13,0x23,0; 1x 14,0x23,0; 1x 15,0x23,0
+	8767 A HF 1x TX 8x28,0; 1x TX 9x28,0; 1x TX 10x28,0; 1x TX 15x28,0; 1x TX 20x28,0; 1x TX 25x28,0; 1x TX 27x28,0; 1x TX 30x28,0; 1x TX 40x28,0
○	8740 A HF 1x 3,0x28,0; 1x 4,0x28,0; 1x 4,0x100,0; 1x 5,0x28,0; 1x 5,0x100,0; 1x 6,0x28,0; 1x 6,0x100,0; 1x 8,0x28,0; 1x 8,0x100,0
	9820 1x 172,0x30,0x392,0

Insert en mousse 9721 jeu de cliquet 8000 B Zyklop 3/8" 1



3/8"



05150111001		
○	8000 B	1x 3/8"x199,0
●○	8794 SB	1x 3/8"x125,0
●○	8794 LB	1x 3/8"x200,0
●○	8795 B	1x 3/8"x50,0
●○	8794 B	1x 3/8"x76,0
●	8790 HMB	1x 6,0x29,0; 1x 7,0x29,0; 1x 8,0x29,0; 1x 9,0x29,0; 1x 10,0x29,0; 1x 11,0x29,0; 1x 12,0x29,0; 1x 13,0x29,0; 1x 14,0x29,0; 1x 15,0x29,0; 1x 16,0x30,0; 1x 17,0x30,0; 1x 18,0x30,0; 1x 19,0x30,0; 1x 20,0x30,0; 1x 21,0x30,0; 1x 22,0x30,0; 1x 24,0x32,0
	9821	1x 172,0x30,0x392,0

Insert en mousse 9723 jeu de douille-embouts Zyklop B 3/8" 1



3/8"



05150113001		
●●	8784 B1	1x 1/4"x3/8"x44,0
⊗	8767 B HF	1x TX 15x35,0; 1x TX 20x35,0; 1x TX 25x35,0; 1x TX 25x107,0; 1x TX 27x35,0; 1x TX 27x107,0; 1x TX 30x35,0; 1x TX 30x107,0; 1x TX 40x35,0; 1x TX 40x107,0
○	8740 B HF	1x 4,0x35,0; 1x 4,0x107,0; 1x 5,0x35,0; 1x 5,0x107,0; 1x 6,0x35,0; 1x 6,0x107,0; 1x 7,0x38,5; 1x 8,0x38,5; 1x 8,0x100,0; 1x 10,0x38,5; 1x 10,0x100,0
	9823	1x 172,0x30,0x392,0

Insert en mousse 9722 jeu de cliquet 8000 C Zyklop 1/2" 1



1/2"



05150112001		
○	8000 C	1x 1/2"x277,0
●○	8794 LC	1x 1/2"x250,0
●○	8794 SC	1x 1/2"x125,0
●○	8795 C	1x 1/2"x69,0
●○	8794 C	1x 1/2"x52,0
●	8790 HMC	1x 10,0x37,0; 1x 11,0x37,0; 1x 12,0x37,0; 1x 13,0x37,0; 1x 14,0x37,0; 1x 15,0x37,0; 1x 16,0x37,0; 1x 17,0x37,0; 1x 18,0x37,0; 1x 19,0x37,0; 1x 20,0x37,0; 1x 21,0x37,0; 1x 22,0x37,0; 1x 24,0x37,0; 1x 27,0x40,0; 1x 30,0x42,0; 1x 32,0x42,0
○	8740 C HF	1x 4,0x60,0; 1x 4,0x140,0; 1x 5,0x60,0; 1x 5,0x140,0; 1x 6,0x60,0; 1x 6,0x140,0; 1x 7,0x60,0; 1x 8,0x60,0; 1x 10,0x60,0
	9822	1x 344,0x30,0x392,0

Insert en mousse 9730 jeu 6000 Joker 1



05150120001		
	6000 Joker	1x 8x144; 1x 10x159; 1x 11x165; 1x 12x170,7; 1x 13x177; 1x 14x188; 1x 15x200; 1x 16x212; 1x 17x224; 1x 18x235; 1x 19x246
	9830	1x 172,0x30,0x392,0

Insert en mousse 9731 jeu 6003 Joker 1



05150121001	
6003 Joker	1x 6x105; 1x 7x110; 1x 8x115; 1x 9x120; 1x 10x125; 1x 11x135; 1x 12x148; 1x 13x160; 1x 14x167; 1x 15x174; 1x 16x182; 1x 17x190; 1x 18x210; 1x 19x230,0; 1x 20x230,0; 1x 21x260; 1x 22x260; 1x 24x280
Décapsuleur	1x 148
9831	1x 344,0x30,0x392,0

Insert en mousse 9732 jeu 6004 Joker 1



05150122001	
6004 Joker XS	1x 7-10 (1/4"-3/8")x117
6004 Joker S	1x 10-13 (7/16"-1/2")x154
6004 Joker M	1x 13-16 (1/2"-5/8")x188
6004 Joker L	1x 16-19 (5/8"-3/4")x224
6004 Joker XL	1x 19-24 (3/4"-15/16")x256
9832	1x 172,0x30,0x392,0

Insert en mousse 9740 jeu de clés coudées 1



Insert en mousse 9750 jeu Kraftform Kompakt et Tool-Check PLUS 1



05150150001	
1x Tool-Check PLUS	
● 8001 A	1x 1/4"x87,0
● 813	1x 1/4"x78
● 889/4/1 K	1x 1/4"x50
○ 870/1	1x 1/4"x25 ¹⁾
● 8790 HMA	1x 5.5x23.0; 1x 6.0x23.0; 1x 7.0x23.0; 1x 8.0x23.0; 1x 10.0x23.0; 1x 12.0x23.0; 1x 13.0x23.0
⊕ 851/1 TZ	2x PH 1x25; 3x PH 2x25; 1x PH 3x25
⊕ 855/1 TH	1x PZ 1x25; 3x PZ 2x25; 1x PZ 3x25
⊕ 867/1 TZ TORX®	1x TX 10x25; 1x TX 15x25; 1x TX 20x25; 1x TX 25x25; 1x TX 30x25; 1x TX 40x25
⊕ 867/1 Z TORX® BO	1x TX 10x25; 1x TX 15x25; 1x TX 20x25; 1x TX 25x25; 1x TX 30x25
○ 840/1 Z	1x 3.0x25; 1x 4.0x25; 1x 5.0x25; 1x 6.0x25; 1x 8.0x25
⊖ 800/1 TZ	1x 1.0x5.5x25
1x Kraftform Kompakt 60	
● 816 R	1x 1/4"x119
⊕ 851/4 Z	1x PH 1x89; 1x PH 2x89; 1x PH 3x89 ²⁾
⊕ 855/4 Z	1x PZ 1x89; 1x PZ 2x89; 1x PZ 3x89 ²⁾
⊕ 867/4 Z TORX® BO	1x TX 10x89; 1x TX 15x89; 1x TX 20x89; 1x TX 25x89; 1x TX 30x89
⊖ 800/4 Z	1x 1.0x5.5x89
○ 840/4 Z	1x 3.0x89; 1x 4.0x89; 1x 5.0x89; 1x 6.0x89 ²⁾
Bande autocollante 70	1x 50.0x70.0
1x 393 S	
●	1x 1/4"x173,5
1x 9850	
	1x 172,0x30,0x392,0

¹⁾ Avec bille ; pour douilles à carré à actionnement manuel

²⁾ Lame hexagonale

05150140001	
1x 950/9 Hex-Plus Multicolour 1	
○ 950 SPKL Multicolour	1x 1.5x90; 1x 2.0x101; 1x 2.5x112; 1x 3.0x123; 1x 4.0x137; 1x 5.0x154; 1x 6.0x172; 1x 8.0x195; 1x 10.0x224
1x 967/9 TX XL Multicolour 1	
⊕ 967 SXL TORX® Multicolour	1x TX 8x90; 1x TX 9x101; 1x TX 10x112
⊕ 967 SPKXL TORX® Multicolour	1x TX 15x123; 1x TX 20x137; 1x TX 25x154; 1x TX 27x172; 1x TX 30x195; 1x TX 40x224
1x 9500	
	1x 64,6
1x Mètre-ruban de poche BM 100, graduation métrique STABILA®, 3 m, article 19570	
	1x 3000,0
1x 9840	
	1x 172,0x30,0x392,0

Insert en mousse 9780 jeu de pinces KNIPEX 1



05150180001		
	Pince universelle KNIPEX 03 05 180	1x 180
	Pince multiprise de pointe KNIPEX Cobra® 87 05 250	1x 250
	Pince coupante de côté à forte démultiplication KNIPEX 74 05 160	1x 160
9880		1x 172,0x30,0x392,0

Insert en mousse 9782 jeu de marteaux 1



05150182001		
	Marteau rivoir PICARD® 500 g, 0000101-500	1x 500,0
	Chasse-goupilles Exklusiv RENNSTEIG	1x 452 003 6 RC, 3,0x150; 1x 4520046RC, 4,0x150; 1x 4520066RC, 6,0x150; 1x 452 008 6 RC, 8,0x150
	Burin plat RENNSTEIG 310 250 1	1x 25,0x13,0x23,0
9882		1x 172,0x30,0x392,0

Insert en mousse 9781 jeu de pinces KNIPEX 2

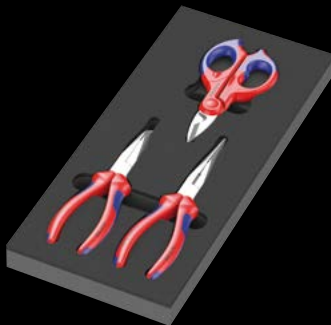

05150181001		
	Pince demi-ronde avec tranchant (pince bec de cigogne) KNIPEX 26 15 200	1x 200
	Pince de mécanicien KNIPEX 38 25 200	1x 200
	Ciseaux d'électricien KNIPEX 95 05 155	1x 155
9881		1x 172,0x30,0x392,0

Insert en mousse 9783 jeu de limes PFERD 1

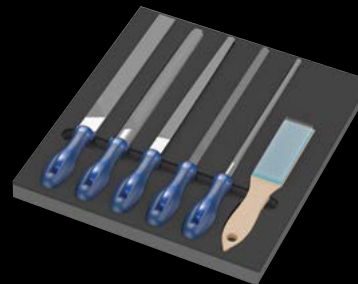

05150183001		
	Lime d'atelier carrée PFERD PF1142 250 H2	1x 250
	Lime d'atelier demi-ronde, pointue PFERD 1152SP 250 H2	1x 250
	Lime d'atelier ronde PFERD 1162 250 H2	1x 250
	Lime d'atelier plate à main PFERD 1112 250 H2	1x 250
	Lime d'atelier triangulaire PFERD 1132 250 H2	1x 250
	Brosse à limes PFERD HBF fil en acier Ø 0,15	1x 232
9883		1x 344,0x30,0x392,0

Nous nous réservons le droit de modifier à tout moment et sans préavis l'ensemble des indications portées dans ce catalogue relativement aux caractéristiques des produits, modèles et versions. Nous déclinons toute responsabilité pour les fautes ou erreurs d'impression.



Wera Outillages S.A.S. France
13, rue Ampère
F - 67500 Haguenau

Téléphone : +33 9 72 61 16 52
E - Mail : info@wera-outillages.fr

Wera Werkzeuge GmbH
Korzter Straße 21-25
D-42349 Wuppertal, Allemagne

Phone: +49 (0)202/40 45-0
E-Mail: info@wera.de

www.wera.de



FR 05 510264 024 - 0053701 - 01