

# Innovations 2024



Safe-Torque Speed



Zyklop Comfort Ratchet



Ratchet Screwdriver





# What an eye-catcher!

## Zyklop Comfort ratchet $\frac{3}{8}$ "

- Pleasant feel thanks to the plastic sleeve
- Plastic coating protects surfaces from damage
- Fine toothing with 80 teeth for a short return angle of only  $4.5^\circ$
- Extremely slim design with a soft, ergonomic grip zone for easy work even in very confined spaces
- Safe socket lock via push button, convenient direction change thanks to the reversing lever



### Plastic coated



The plastic sleeve makes working comfortable and safe even at low temperatures.



### Fine-tooth design

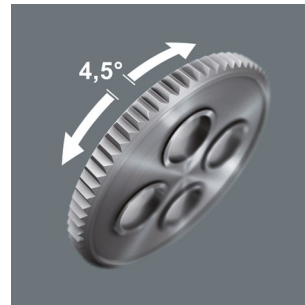

With its fine toothing with 80 teeth, the Zyklop Comfort ratchet allows a short return angle of only  $4.5^\circ$ .

### For tight spaces



With its extremely slim design, the Zyklop Comfort ratchet allows easy working even in very confined spaces.



### Ball lock



The ball lock ensures sockets and accessories are securely fitted, providing increased safety during operation. A short press on the release button allows the tool to be changed quickly.

### 8100 SB 12 Zyklop Comfort Ratchet set, reversing lever, 3/8" drive, metric



16-piece set; in surface-friendly, compact and extremely robust textile box. Small size and low weight for better mobility.

1 Zyklop Comfort ratchet with reversing lever with 3/8" drive, 14 Zyklop Impaktor sockets, 1 Zyklop extension

05005530001		
○	8010 B	1x 3/8"x230.0
●	8790 B Impaktor	1x 8.0x30.0; 1x 10.0x30.0; 1x 11.0x30.0; 1x 12.0x30.0; 1x 13.0x30.0; 1x 14.0x30.0; 1x 15.0x30.0; 1x 16.0x30.0; 1x 17.0x30.0; 1x 18.0x30.0; 1x 19.0x30.0; 1x 21.0x32.0; 1x 22.0x32.0; 1x 24.0x32.0
○ ○	8798 B	1x 3/8"x152.4

### 8100 SB 13 Zyklop Comfort Ratchet set, reversing lever, 3/8" drive, imperial



11-piece set; in surface-friendly, compact and extremely robust textile box. Small size and low weight for better mobility.

1 Zyklop Comfort ratchet with reversing lever with 3/8" drive, 9 Zyklop Impaktor sockets, 1 Zyklop extension

05005531001		
○	8010 B	1x 3/8"x230.0
●	8790 B Impaktor	1x 1/4"x30.0; 1x 5/16"x30.0; 1x 3/8"x30.0; 1x 7/16"x30.0; 1x 1/2"x30.0; 1x 9/16"x30.0; 1x 5/8"x30.0; 1x 11/16"x30.0; 1x 3/4"x30.0
○ ○	8798 B	1x 3/8"x152.4

### 8010 B Zyklop Comfort Ratchet, with reversing lever, with 3/8" drive



**Application:** For 3/8" square head sockets as well as 3/8" connectors with square head drive and ball lock

**Design:** Convenient plastic sleeve; slim design for working even in very confined spaces; fine toothing with 80 teeth for a return angle of only 4.5°; reversing lever for comfortable direction change; with safe socket locking via push-button

05005540001	
3/8"	230.0

### 9607 Magnetic rail B Impaktor 1

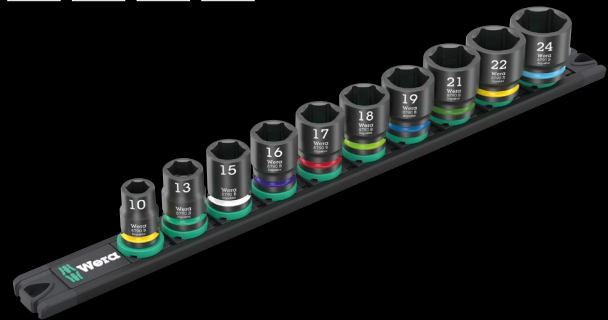

10-piece set; on a magnetic rail for temporary attachment on wall, shelf or workshop trolley. Smooth rotary mechanism for safe storage and easy access of the tools.

10 Impaktor sockets with 3/8" drive. With hexagon profile and socket with hole. For use with electric or pneumatic wrenches with 3/8" drive. "Take it easy" Tool finder: With colour coding by size - for quick and easy identification of the required tool.

05005451001		
●	8790 B Impaktor	1x 10.0x30.0; 1x 13.0x30.0; 1x 15.0x30.0; 1x 16.0x30.0; 1x 17.0x30.0; 1x 18.0x30.0; 1x 19.0x30.0; 1x 21.0x32.0; 1x 22.0x32.0; 1x 24.0x32.0
	9603	1x 30.0x340.0



## Magnetic

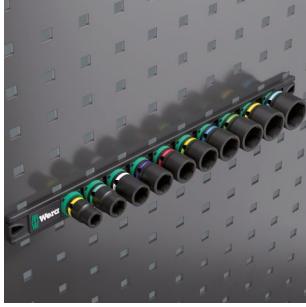

Thanks to the magnet, the rail is suitable for temporary attachment to the wall, shelf or workshop trolley.



TWIST TO UNLOCK

### Twist-to-unlock mechanism

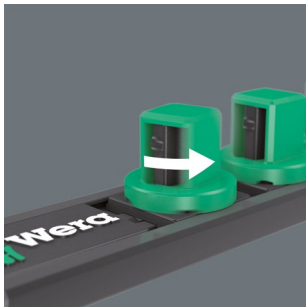

With its twist-to-unlock mechanism the socket rail ensures easy access of the sockets. At the same time the sockets are held securely.

## 9608 Magnetic rail B Impaktor Imperial 1

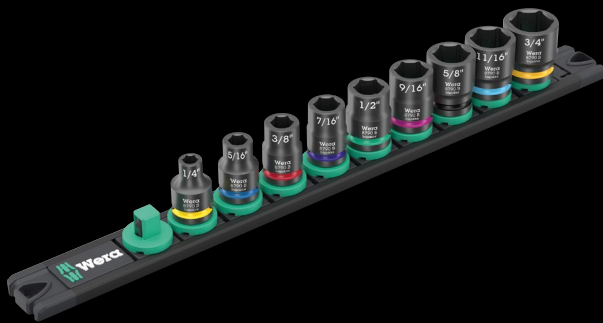

9-piece set; on a magnetic rail for temporary attachment on wall, shelf or workshop trolley. Smooth rotary mechanism for safe storage and easy access of the tools.

9 Impaktor sockets with  $\frac{3}{8}$ " drive. With hexagon profile and socket with hole. For use with electric or pneumatic wrenches with  $\frac{3}{8}$ " drive. "Take it easy" Tool finder: With colour coding by size – for quick and easy identification of the required tool.

05005452001	
	<b>8790 B Impaktor</b> 1x $\frac{1}{4}$ "x30.0; 1x $\frac{5}{16}$ "x30.0; 1x $\frac{3}{8}$ "x30.0; 1x $\frac{7}{16}$ "x30.0; 1x $\frac{1}{2}$ "x30.0; 1x $\frac{9}{16}$ "x30.0; 1x $\frac{5}{8}$ "x30.0; 1x $\frac{11}{16}$ "x30.0; 1x $\frac{3}{4}$ "x30.0
	<b>9601</b> 1x 30.0x340.0

## 8790 B Impaktor socket with $\frac{3}{8}$ " drive



**Application:** For external hexagon bolts and screws

**Design:** For use with electric or pneumatic impact wrenches with  $\frac{3}{8}$ " drive, with retaining pin hole, chrome-molybdenum, matt black finish. "Take it easy" tool finder: Colour coding to enable the desired socket to be easily located.

	mm	mm	mm	mm	mm
05005500001	8.0	30.0	14.1	19.0	
05005501001	10.0	30.0	16.6	19.0	
05005502001	11.0	30.0	17.8	19.0	
05005503001	12.0	30.0	18.2	19.0	
05005504001	13.0	30.0	20.0	22.0	
05005505001	14.0	30.0	21.0	22.0	
05005506001	15.0	30.0	22.0	22.0	
05005507001	16.0	30.0	22.0	24.0	
05005508001	17.0	30.0	23.0	25.0	
05005509001	18.0	30.0	23.0	26.0	
05005510001	19.0	30.0	25.0	27.8	
05005511001	21.0	32.0	27.0	30.0	
05005512001	22.0	32.0	28.0	32.0	
05005513001	24.0	32.0	30.0	34.0	
05005514001		$\frac{1}{4}$ "	30.0	11.0	19.0
05005515001		$\frac{5}{16}$ "	30.0	14.1	19.0
05005516001		$\frac{3}{8}$ "	30.0	16.6	19.0
05005517001		$\frac{7}{16}$ "	30.0	17.8	19.0
05005518001		$\frac{1}{2}$ "	30.0	20.0	22.0
05005519001		$\frac{9}{16}$ "	30.0	21.0	22.0
05005520001		$\frac{5}{8}$ "	30.0	22.0	24.0
05005521001		$\frac{11}{16}$ "	30.0	23.0	25.0
05005522001		$\frac{3}{4}$ "	30.0	25.0	28.0
05005523001		$\frac{13}{16}$ "	32.0	27.0	30.0
05005524001		$\frac{7}{8}$ "	32.0	28.0	32.0
05005525001		$\frac{15}{16}$ "	32.0	30.0	34.0
05005526001		1"	32.0	32.0	36.0



## For electric or pneumatic impact wrenches



The Impaktor technology ensures above-average service life of the Impaktor socket wrench plug-ins even under extreme conditions.

Intuitive and very compact ratchet mechanism that can also be used for spinning.





## Ratchet functionality



The integrated ratchet with fine tothing (36 teeth) and a return angle of 10° eases and accelerates screwdriving without having to reposition the tool.

## Rapid screwdriving



The ratchet mechanism also allows fast "spinning" while screwdriving.

## Ratchet mechanism in the handle



The integrated ratchet with fine tothing ensures fast and safe working. The ratchet mechanism is completely embedded in the handle. Thanks to the small size of the handle the ratchet can even be used in constricted screwdriving situations.

## Changing ratchet direction



Ergonomic design of the reverse direction switch.



## Kraftform Kompakt 838 RA S Set 1



14-piece set

One 838 RA S bitholding screwdriver with ratchet functionality, 13 bits, chemically nickel-plated with "Take it easy" Tool finder: With size stamping and colour coding by output to help you find the required bit easily, 1/4", 50 mm length

05051060001		
●	838 RA S	1x 1/4"x102
+	851/4 BTZ	1x PH 1x50; 1x PH 2x50
+	855/4 BTZ	1x PZ 1x50; 1x PZ 2x50
⊕	867/4 TORX® BTZ	1x TX 10x50; 1x TX 15x50; 1x TX 20x50; 1x TX 25x50
○	840/4 BTZ	1x 2.5x50; 1x 3.0x50; 1x 4.0x50; 1x 5.0x50
⊖	800/4 BTZ	1x 0.8x5.5x50
⊖	Hook and Loop Fastener Strip 70	1x 50.0x70.0

## Kraftform Kompakt 838 RA S Imperial Set 1



14-piece set

One 838 RA S bitholding screwdriver with ratchet functionality, 13 bits, chemically nickel-plated with "Take it easy" Tool finder: With size stamping and colour coding by output to help you find the required bit easily, 1/4", 50 mm length

05051065001		
●	838 RA S	1x 1/4"x102
+	851/4 BTZ	1x PH 1x50; 1x PH 2x50
⊕	867/4 TORX® BTZ	1x TX 10x50; 1x TX 15x50; 1x TX 20x50; 1x TX 25x50
○	840/4 Z	1x 9/64"x50; 1x 5/32"x50; 1x 3/16"x50; 1x 7/32"x50
⊖	800/4 BTZ	1x 0.8x5.5x50
○	868/4	1x # 1x50; 1x # 2x50
⊖	Hook and Loop Fastener Strip 70	1x 50.0x70.0

## 838 RA S Bitholding screwdriver with ratchet functionality, 1/4"



**Application:** Suitable for bits with 1/4" external hexagon drive

**Design:** Ratchet with fine toothing integrated in the handle (36 teeth, return angle 10°); 1/4" hexagonal socket mounting for bits with 1/4" external hexagon drive, magnetic

**Handle:** Kraftform with anti-roll protection, multi-component

05051492001			
●	⌀	ℓ	ℓ
		mm	mm
	1/4"	102	84



### "Take it easy" tool finder

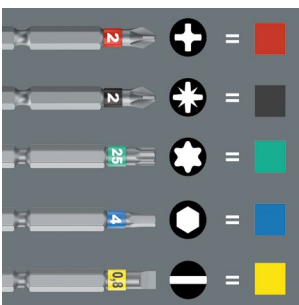

"Take it easy" tool finder with colour coding according to profiles and size stamp – for simple and rapid accessing of the required tool.



## Kraftform Kompakt 838 RA-R M Set 1



15-piece set

One 838 RA-R M bitholding screwdriver with ratchet functionality, 14 bits, chemically nickel-plated, 1/4", 89 mm length

05051061001	
⊙	<b>838 RA-R M</b> 1x 1/4"x123.5
⊕	<b>851/4 Z</b> 1x PH 1x89; 1x PH 2x89; 1x PH 3x89 <sup>1)</sup>
⊕	<b>855/4 Z</b> 1x PZ 1x89; 1x PZ 2x89; 1x PZ 3x89 <sup>1)</sup>
⊗	<b>867/4 Z TORX®</b> 1x TX 10x89; 1x TX 15x89; 1x TX 20x89; 1x TX 25x89
○	<b>840/4 Z</b> 1x 3.0x89; 1x 4.0x89; 1x 5.0x89
◐	<b>800/4 Z</b> 1x 1.0x5.5x89
	<b>Hook and Loop Fastener Strip 70</b> 1x 50.0x70.0

<sup>1)</sup> Hexagonal blade

## Kraftform Kompakt 838 RA-R M Imperial Set 1



15-piece set

One 838 RA-R M bitholding screwdriver with ratchet functionality, 14 bits, chemically nickel-plated, 1/4", 89 mm length

05051066001	
⊙	<b>838 RA-R M</b> 1x 1/4"x123.5
⊕	<b>851/4 Z</b> 1x PH 1x89; 1x PH 2x89; 1x PH 3x89 <sup>1)</sup>
⊗	<b>867/4 Z TORX®</b> 1x TX 10x89; 1x TX 15x89; 1x TX 20x89; 1x TX 25x89
○	<b>840/4 Z</b> 1x 1/8"x89; 1x 5/32"x89; 1x 3/16"x89
◐	<b>800/4 Z</b> 1x 1.0x5.5x89
○	<b>868/4</b> 1x # 1x89; 1x # 2x89; 1x # 3x89
	<b>Hook and Loop Fastener Strip 70</b> 1x 50.0x70.0

<sup>1)</sup> Hexagonal blade

## 838 RA-R M Bitholding screwdriver with ratchet functionality, 1/4"



**Application:** Suitable for bits with 1/4" external hexagon drive as per DIN ISO 1173-C 6.3 and E 6.3 and Wera connection series 1 and 4

**Design:** Ratchet with fine toothing integrated in the handle (36 teeth, return angle 10°); 1/4" hexagon with Rapidaptor rapid-in, rapid-out, rapid-spin, chuck-all and single-hand technology, magnetic

**Handle:** Kraftform with anti-roll protection, multi-component

05051493001	⊙	⊕	⊗
	mm	mm	
	1/4"	123,5	98



### Chuck-all

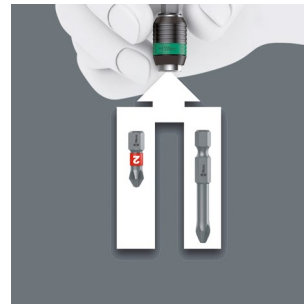

The Rapidaptor quick-release chucks hold 1/4" DIN ISO 1173-C 6,3 and E 6,3 as well as Wera series 1 and 4 bits.



### Rapid-in and self-lock

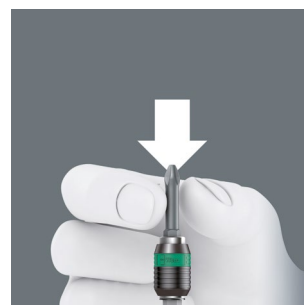

The bit can be pushed into the adaptor without moving the sleeve. The lock is activated automatically as soon as the bit is applied to the screw. Bits are held securely and wobble-free.

## Kraftform Kompakt VDE 17 RA 1\*



17-piece set

One 837 i RA bitholding screwdriver with ratchet functionality (40 teeth, 9° return angle), one 817 VDE bitholding screwdriver, each solely for Wera VDE blades. 15 VDE blades (each 157 mm length) with "Take it easy" Tool finder: Colour coding by profile and laser-engraved size indication

05006618001		
●	837 i RA	1x 9x115
●	817 VDE	1x 9x98
+	Kraftform Kompakt VDE 62 i Take it easy	1x PH 1x157; 1x PH 2x157
+	Kraftform Kompakt VDE 65 i Take it easy	1x PZ 1x157; 1x PZ 2x157
+	Kraftform Kompakt VDE 65 i PZ/S Take it easy	1x # 1x157; 1x # 2x157
+	Kraftform Kompakt VDE 67 i Take it easy	1x TX 10x157; 1x TX 15x157; 1x TX 20x157; 1x TX 25x157
+	Kraftform Kompakt VDE 60 i Take it easy	1x 0.4x2.5x157; 1x 0.8x4.0x157; 1x 1.0x5.5x157; 1x 1.2x6.5x157
+	Kraftform Kompakt VDE 60 iS Take it easy	1x 0.6x3.5x157

\* Available from September 2024

## Kraftform Kompakt VDE 17 RA Imperial 1\*



17-piece set

One 837 i RA bitholding screwdriver with ratchet functionality (40 teeth, 9° return angle), one 817 VDE bitholding screwdriver, each solely for Wera VDE blades. 15 VDE blades (each 157 mm length) with "Take it easy" Tool finder: Colour coding by profile and laser-engraved size indication

05006619001		
●	837 i RA	1x 9x115
●	817 VDE	1x 9x98
+	Kraftform Kompakt VDE 62 i Take it easy	1x PH 1x157; 1x PH 2x157
+	Kraftform Kompakt VDE 65 i PZ/S Take it easy	1x # 1x157; 1x # 2x157
+	Kraftform Kompakt VDE 67 i Take it easy	1x TX 10x157; 1x TX 15x157; 1x TX 20x157; 1x TX 25x157
+	Kraftform Kompakt VDE 60 i Take it easy	1x 0.4x2.5x157; 1x 0.8x4.0x157; 1x 1.0x5.5x157; 1x 1.2x6.5x157
+	Kraftform Kompakt VDE 60 iS Take it easy	1x 0.6x3.5x157
○	Kraftform Kompakt VDE 68 i Take it easy	1x # 1x157; 1x # 2x157

\* Available from September 2024



## 837 i RA Kraftform Bitholding screwdriver with ratchet functionality\*



**Application:** Solely for Wera VDE blades

**Design:** Ratchet with fine toothing integrated in the handle (40 teeth, return angle 9°)

**Handle:** Kraftform with anti-roll protection, multi-component

	mm	mm
05057490001	9	115

\* Available from September 2024



### "Take it easy" Tool Finder

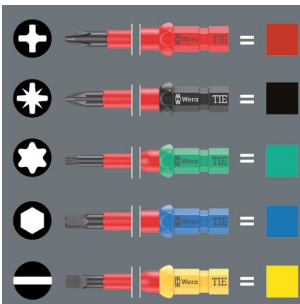

The Kraftform Kompakt VDE blades are equipped with the "Take it easy" Tool finder. The colour coding by profile and the laser-engraved size indication make it easy to identify the required tool quickly.

### Fast spinning

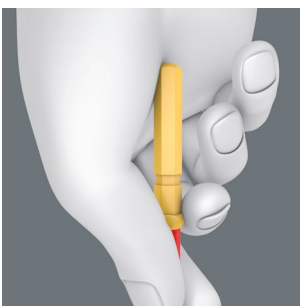

The palm of your hand is comfortably supported on the rounded shape of the rear end of the blades. This allows quick spinning of the blade and accelerates the screwdriving process.

## The 837 i RA bitholding screwdriver with ratchet functionality



The integrated ratchet with fine toothing (40 teeth and a return angle of 9°) eases and accelerates screwdriving without having to reposition the tool.

### Rapid screwdriving

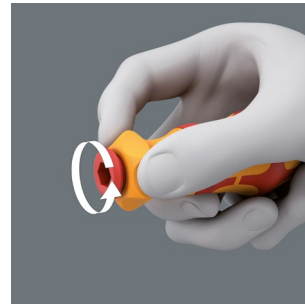

The ratchet mechanism also allows fast "spinning" while screwdriving.

## The 817 VDE bitholding screwdriver

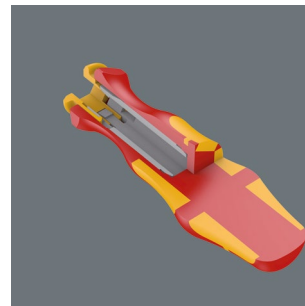

The bitholding screwdriver is suitable solely for Wera VDE blades. Kraftform Plus handle for comfortable ergonomic screwdriving, avoiding blisters and calluses. Hard handle zones for high working speeds, while soft handle zones guarantee a high torque transfer.



### Individually tested



Each Kraftform Kompakt VDE set has been tested individually at 10,000 volts, in accordance with IEC 60900. This ten-times-higher testing load guarantees safe working at their maximum permitted load of 1,000 volts.

New: Kraftform Kompakt VDE interchangeable blades with "Take it easy" Tool finder.





## Kraftform Kompakt VDE Big Pack 1



26-piece set

2 Kraftform 817 VDE bitholding screwdrivers solely for Wera VDE blades

24 VDE blades (each 157 mm length) with "Take it easy" Tool finder with colour coding by profile and laser-engraved size indication

Robust textile roll pouch

## Kraftform Kompakt VDE 17 Universal 1 Tool finder



17-piece set

2 Kraftform 817 VDE bitholding screwdrivers solely for Wera VDE blades

15 VDE blades (each 157 mm length) with "Take it easy" Tool finder: Colour coding by profile and laser-engraved size indication

In a robust belt pouch

05006617001	
●	817 VDE 2x 9x98
⊕	Kraftform Kompakt VDE 62 iS Take it easy 1x PH 1x157; 1x PH 2x157
⊕	Kraftform Kompakt VDE 65 iS Take it easy 1x PZ 1x157; 1x PZ 2x157
⊕	Kraftform Kompakt VDE 62 iS PH/S Take it easy 1x # 1x157; 1x # 2x157
⊕	Kraftform Kompakt VDE 65 iS PZ/S Take it easy 1x # 1x157; 1x # 2x157
⊗	Kraftform Kompakt VDE 67 i Take it easy 1x TX 8x157; 1x TX 9x157; 1x TX 10x157; 1x TX 30x157
⊗	Kraftform Kompakt VDE 67 iS Take it easy 1x TX 15x157; 1x TX 20x157; 1x TX 25x157
○	Kraftform Kompakt VDE 64 i Take it easy 1x 2.5x157; 1x 3.0x157; 1x 4.0x157; 1x 5.0x157
●	Kraftform Kompakt VDE 60 i Take it easy 1x 0.4x2.5x157; 1x 1.2x6.5x157
●	Kraftform Kompakt VDE 60 iS Take it easy 1x 0.6x3.5x157; 1x 0.8x4.0x157; 1x 1.0x5.5x157

05006611001	
●	817 VDE 2x 9x98
⊕	Kraftform Kompakt VDE 62 i Take it easy 1x PH 1x157; 1x PH 2x157
⊕	Kraftform Kompakt VDE 65 i Take it easy 1x PZ 1x157; 1x PZ 2x157
⊕	Kraftform Kompakt VDE 65 i PZ/S Take it easy 1x # 1x157; 1x # 2x157
⊗	Kraftform Kompakt VDE 67 i Take it easy 1x TX 10x157; 1x TX 15x157; 1x TX 20x157; 1x TX 25x157
●	Kraftform Kompakt VDE 60 i Take it easy 1x 0.4x2.5x157; 1x 0.8x4.0x157; 1x 1.0x5.5x157; 1x 1.2x6.5x157
●	Kraftform Kompakt VDE 60 iS Take it easy 1x 0.6x3.5x157
	Hook and Loop Fastener Strip 70 1x 50.0x70.0





Not only safe,  
but also fast.

### Safe-Torque Speed

- Torque screwdriver with quick torque adjustment
- Easy and quick torque setting
- Fixed position (Torque Lock) for unlimited tightening and loosening moments
- Secure slip-over torque function for clockwise/anti-clockwise torque-control
- The tool cannot be overtightened (accuracy  $\pm 10\%$ )



### Five selectable tightening torques



Five selectable tightening torques and one fixed position (Torque Lock) for unlimited tightening and loosening moments.

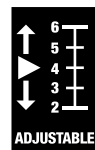

### Simple setting



Easy setting of the selectable tightening torques.



### Excess-load signal

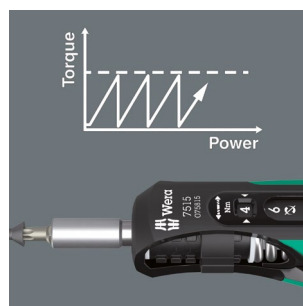

Distinctly audible and noticeable excess-load signal when the pre-set torque is reached.



## 7515/16 Krafftform Safe-Torque Speed Universal 1



16-piece set

Folding pouch with one 7515 torque screwdriver with easy quick torque setting and 15 tough bits (89 mm length)

05075851001	
7515	1x 1/4"x2.0x3.0x4.0x5.0x6.0x147.5
851/4 Z	1x PH 2x89
867/4 Z TORX® B0	1x TX 10x89; 1x TX 15x89; 1x TX 20x89; 1x TX 25x89; 1x TX 30x89
867/4 IP TORX PLUS®	1x 10 IPx89; 1x 15 IPx89; 1x 20 IPx89; 1x 25 IPx89; 1x 30 IPx89
840/4 Z	1x 3.0x89; 1x 4.0x89; 1x 5.0x89; 1x 6.0x89 <sup>1)</sup>

<sup>1)</sup> Hexagonal blade



## 7515/7 Krafftform Safe-Torque Speed Bicycle 1



7-piece set

Folding pouch with one torque screwdriver 7515 with easy quick torque setting and 6 tough bits (50 mm length), with Wera "Take it easy" Tool finder: size stamping and colour coding by output to help you find the required bit easily

05075850001	
7515	1x 1/4"x2.0x3.0x4.0x5.0x6.0x147.5
867/4 TORX® BTZ	1x TX 10x50; 1x TX 25x50
840/4 BTZ	1x 2.5x50; 1x 3.0x50; 1x 4.0x50; 1x 5.0x50

## 7515 Krafftform Safe-Torque Speed Torque screwdriver, 2-6 Nm



**Application:** Suitable for bits with 1/4" external hexagon drive

**Design:** Five selectable maximum tightening torques and one fixed position; bit mounting with ±10 % precision. Digital torque value display. Reliable signal when the set torque is reached.

**Handle:** Krafftform, multi-component

05075815001	
1/4"	2.0 Nm, 3.0 Nm, 4.0 Nm, 5.0 Nm, 6.0 Nm, 147.5 mm





## For bolting carbide inserts



The tool set is particularly suitable for bolting carbide inserts. The Safe-Torque Speed 7510 torque wrench with its five selectable torque values recommended by leading carbide tool manufacturers ensures a reliable torque-controlled screw connection of replaceable carbide inserts.

### 7510/14 Safe-Torque Speed Tool set for carbide inserts



### 7510 Kraftform Safe-Torque Speed Torque screwdriver, 1-3 Nm

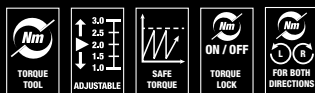

#### 14-piece set

Folding pouch with one Safe-Torque Speed 7510 torque screwdriver with easy quick torque setting and 13 tough bits (25 mm length) for TORX®, TORX PLUS® and hexagonal socket screws

Particularly suitable for easy changing of carbide inserts.

**Application:** Suitable for bits with 1/4" external hexagon drive

**Design:** Five selectable maximum tightening torques and one fixed position; bit mounting with ±10 % precision. Digital torque value display. Reliable signal when the set torque is reached.

**Handle:** Kraftform, multi-component

	1/4" External Hexagon Drive					
	Nm	Nm	Nm	Nm	Nm	mm
05075810001	1.0	1.5	2.0	2.5	3.0	147.5

Part No.	Item	Quantity
05075840001	7510	1x 1/4"x1.0x1.5x2.0x2.5x3.0x147.5
	867/1 IP TORX PLUS®	1x 7 IPx25; 1x 8 IPx25; 1x 9 IPx25; 1x 10 IPx25; 1x 15 IPx25
	867/1 TORX®	1x TX 7x25; 1x TX 8x25; 1x TX 9x25; 1x TX 10x25; 1x TX 15x25
	840/1 Z	1x 2.0x25; 1x 2.5x25; 1x 3.0x25

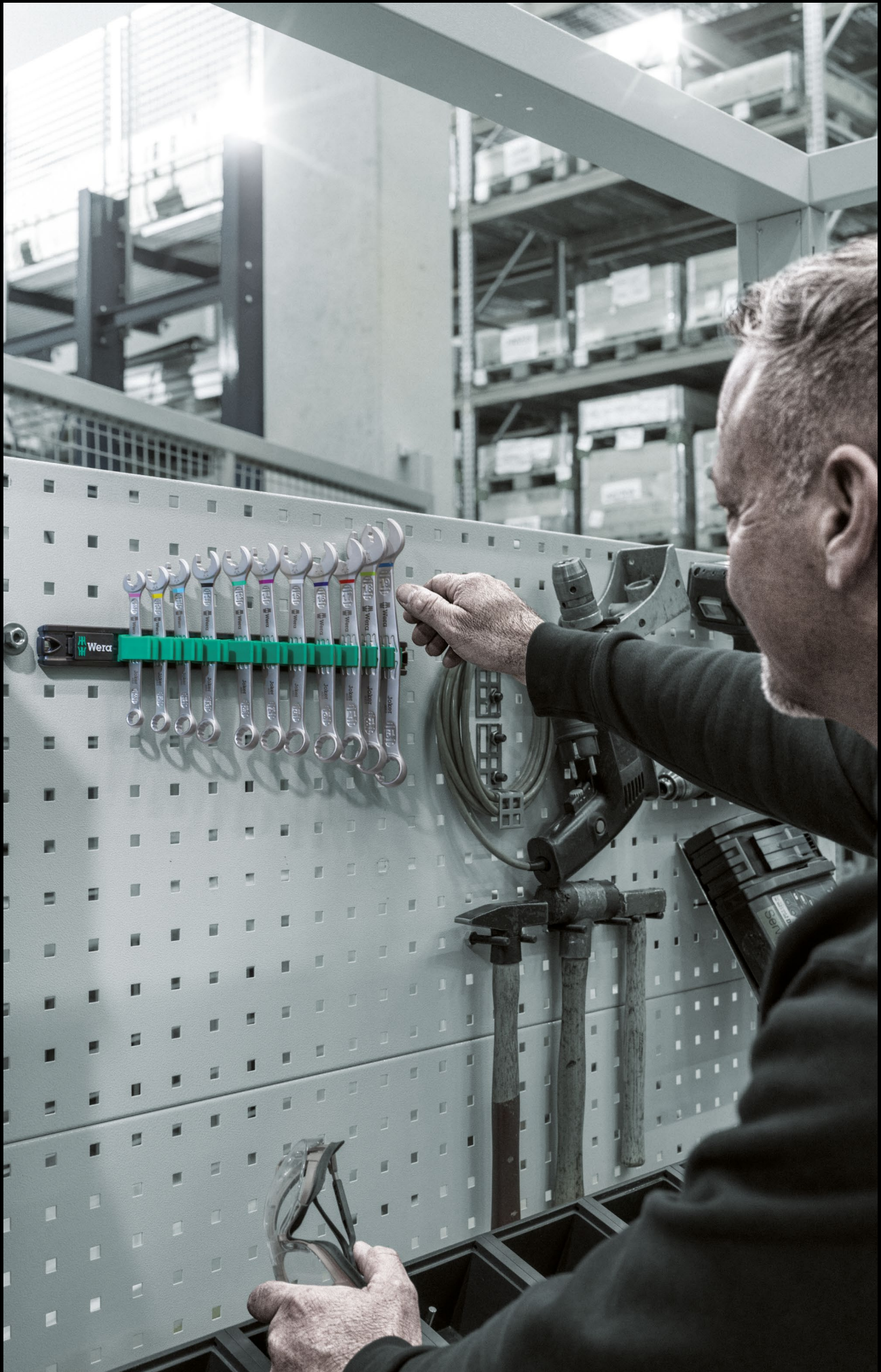



### 9630 Magnetic rail 6000 Joker 1 Ring ratchet spanner set



Ring ratchet spanner set, metric sizes

11-piece set

On a magnetic rail

05020014001		
	<b>6000 Joker</b>	1x 8x144; 1x 10x159; 1x 11x165; 1x 12x170.7; 1x 13x177; 1x 14x188; 1x 15x200; 1x 16x212; 1x 17x224; 1x 18x235; 1x 19x246
	<b>9610</b>	1x 30.0x370.0

### 9631 Magnetic rail 6000 Joker 2 Ring ratchet spanner set



Ring ratchet spanner set, metric sizes

5-piece set

On a magnetic rail

05020015001		
	<b>6000 Joker</b>	1x 8x144; 1x 10x159; 1x 13x177; 1x 17x224; 1x 19x246
	<b>9610</b>	1x 30.0x370.0

### Secure tool holding

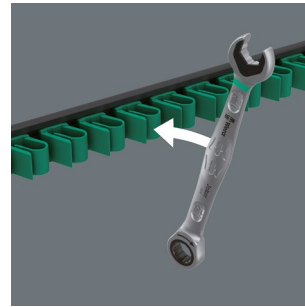

The high-quality aluminium magnetic rail offers space for up to 11 spanners. The clamping springs hold the tools securely.



### Held by magnetic force

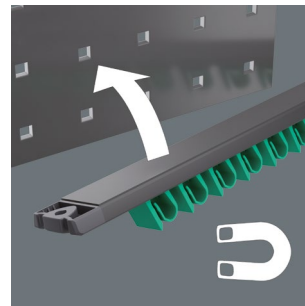

With its strong magnet, the rail can be attached securely to metal surfaces.

### Screw mounting



The rail can also be bolted to the wall.



### Ring ratchet spanner Joker 6000



The Joker's holding function means that nuts and bolts can be held in the jaw and easily positioned where they are needed. Fastening on to the thread can then be done quickly and safely, thanks to the innovative special stop-plate which holds the fastener. No more time-wasting searches

for dropped nuts and bolts! After applying and positioning the nut or bolt, fastening can begin immediately – no additional tools required.

### 9632 Magnetic rail 6000 Joker Imperial 1 Ring ratchet spanner set



Ring ratchet spanner set, imperial sizes

8-piece set

On a magnetic rail

05020016001	
<b>6000 Joker Imperial</b>	1x 5/16"x144; 1x 3/8"x159; 1x 7/16"x165; 1x 1/2"x177; 1x 9/16"x188; 1x 5/8"x212; 1x 11/16"x235; 1x 3/4"x246
<b>9610</b>	1x 30.0x370.0

### 9641 Magnetic rail 6003 Joker 2 Ring spanner set

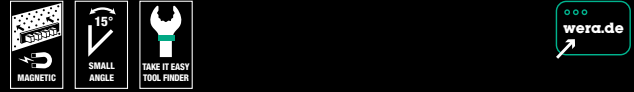

Ring spanner set, metric sizes, open end offset by 7.5°

5-piece set

On a magnetic rail

05020234001	
<b>6003 Joker</b>	1x 8x115; 1x 10x125; 1x 13x160; 1x 17x190; 1x 19x230.0
<b>9610</b>	1x 30.0x370.0

### 9640 Magnetic rail 6003 Joker 1 Ring spanner set

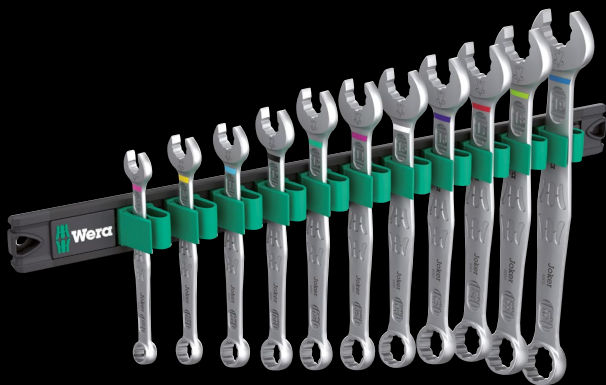
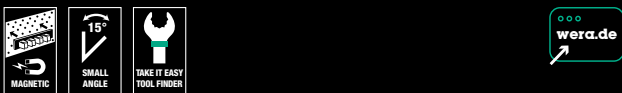

Ring spanner set, metric sizes, open end offset by 7.5°

11-piece set

On a magnetic rail

05020233001	
<b>6003 Joker</b>	1x 8x115; 1x 10x125; 1x 11x135; 1x 12x148; 1x 13x160; 1x 14x167; 1x 15x174; 1x 16x182; 1x 17x190; 1x 18x210; 1x 19x230.0
<b>9610</b>	1x 30.0x370.0

### 9642 Magnetic rail 6003 Joker Imperial 1 Ring spanner set

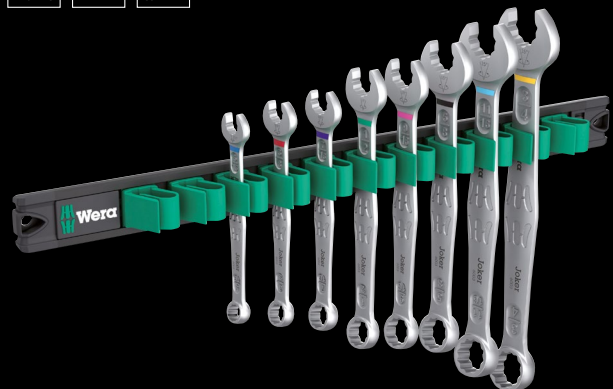
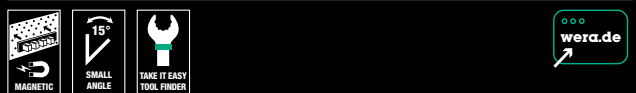

Ring spanner set, imperial sizes, open end offset by 7.5°

8-piece set

On a magnetic rail

05020235001	
<b>6003 Joker Imperial</b>	1x 5/16"x115; 1x 3/8"x125; 1x 7/16"x135; 1x 1/2"x160; 1x 9/16"x167; 1x 5/8"x182; 1x 11/16"x210; 1x 3/4"x230.0
<b>9610</b>	1x 30.0x370.0



## 9610 Joker Magnetic rail, for up to 11 spanners, empty

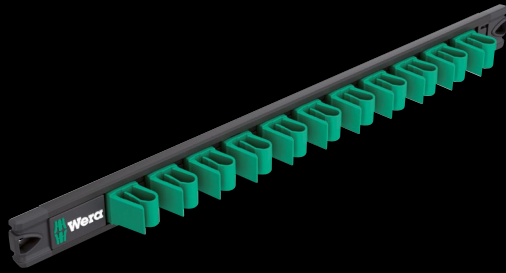

One magnetic rail, empty. For up to 11 Joker spanners. The rail allows temporary attachment to metallic surfaces and can also be bolted to the wall. Thanks to the strong terminals, the rail ensures reliable clamping and easy access to the tools.

	mm	mm
05136413001	30.0	370.0

### Secure tool holding

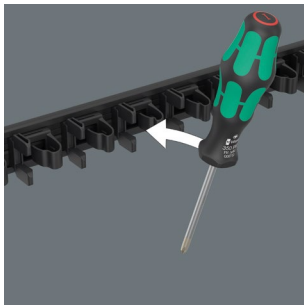

The plastic magnetic rail offers space for up to 9 Kraftform screwdrivers. The clamping springs hold the tools securely.

### Held by magnetic force

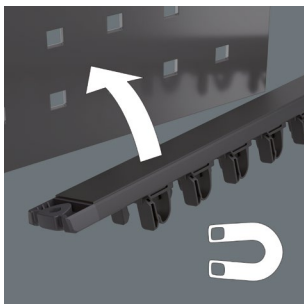

With its strong magnet, the rail can be attached securely to metal surfaces.

### Screw mounting



The rail can also be bolted to the wall.

## 9650 Magnetic rail Kraftform screwdriver set



### 9-piece set

6 Kraftform series 300 screwdrivers; for Phillips-head screws Phillips and Pozidriv (with Lasertip) and TORX® screws. One Kraftform series 100 VDE slotted screwdriver with reduced blade diameter. With "Take it easy" Tool finder: Colour coding by profile and size stamping. 2 chiseldrivers for slotted screws; for screwdriving, chiseling, mortising. One terminal block, which can be securely attached to metal surfaces via magnets. The rail can also be bolted to the wall.

	mm	mm
05051012001		
⊖	932 A	1x 1.0x5.5x100; 1x 1.2x7.0x125
⊕	350	1x PH 2x100
⊕	355	1x PZ 1x80; 1x PZ 2x100
⊗	367 TORX®	1x TX 20x100; 1x TX 25x100
⊖	335	1x 0.8x4.0x100
⊖	160 IS VDE	1x 0.6x3.5x100
	9611	1x 30.0x400.0

## 9611 Magnetic rail for up to 9 Kraftform screwdrivers, empty

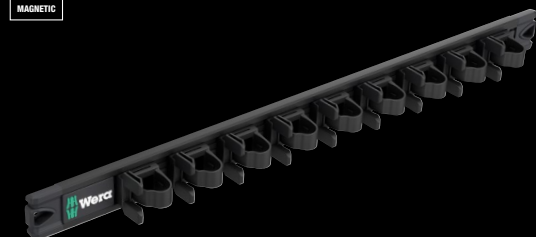

One magnetic rail, empty. For up to 9 Kraftform screwdrivers. The rail allows temporary attachment to metallic surfaces and, thanks to the strong terminals, ensures reliable clamping and easy access to the tools. The rail can also be bolted to the wall.

	mm	mm
05136414001	30.0	400.0







## 9620 Belt holster Set 1



9-piece set

5 Kraftform series 300 screwdrivers; for Phillips-head screws Phillips and Pozidriv (with Lasertip) and TORX® screws. 3 Kraftform series 100 VDE screwdrivers; for Phillips-head screws Phillips (with Lasertip) and slotted screws. With "Take it easy" tool finder: Colour coding by profile and size stamping. One chiseldriver for slotted screws; for screwdriving, chiseling, mortising. One rigid, robust holster - can be attached to the belt.

05136032001		
+	350	1x PH 1x80; 1x PH 2x100
+	355	1x PZ 2x100
+	367 TORX®	1x TX 20x100; 1x TX 25x100
-	932 A	1x 1.2x7.0x125
+	162 i VDE PH	1x PH 1x80; 1x PH 2x100
-	160 i VDE	1x 0.6x3.5x100 <sup>1)</sup>
	9522	1x 170.0x240.0

<sup>1)</sup> without Lasertip

## 9622 Belt holster Set 3



7-piece set

3 Kraftform series 100 VDE screwdrivers; for screwdrivers for square head socket screws and slotted screws. 3 Kraftform series 1800 screwdrivers; for Phillips-head screws Phillips and slotted screws (with Lasertip and ball handle). With "Take it easy" tool finder: Colour coding by profile and size stamping. One chiseldriver for slotted screws; for screwdriving, chiseling, mortising. One rigid, robust holster - can be attached to the belt.

05300306001		
+	1850 PH	1x PH 1x80; 1x PH 2x100
-	1834	1x 1.0x6.0x100
-	932 A	1x 1.0x5.5x100
-	160 i VDE	1x 0.6x3.5x100 <sup>1)</sup>
○	168 i VDE	1x # 1x80; 1x # 2x100
	9522	1x 170.0x240.0

<sup>1)</sup> without Lasertip

## 9621 Belt holster Set 2



7-piece set

3 Kraftform series 100 VDE screwdrivers; for Phillips-head Phillips (with Lasertip) and slotted screws. 3 Kraftform series 1800 screwdrivers; for Phillips-head screws Phillips and slotted screws (with Lasertip and ball handle). With "Take it easy" tool finder: Colour coding by profile and size stamping. One chiseldriver for slotted screws; for screwdriving, chiseling, mortising. One rigid, robust holster - can be attached to the belt.

05136033001		
+	1850 PH	1x PH 1x80; 1x PH 2x100
-	1834	1x 1.0x6.0x100
-	932 A	1x 1.0x5.5x100
+	162 i VDE PH	1x PH 1x80; 1x PH 2x100
-	160 i VDE	1x 0.6x3.5x100 <sup>1)</sup>
	9522	1x 170.0x240.0

<sup>1)</sup> without Lasertip

## Can be attached to your belt



The belt pouch is made of robust material and can be attached to the belt.



## Kraftform Ball-Grip for high torques



The ergonomically shaped Kraftform Ball-Grip fits perfectly in the hand. Its convex shape allows the transmission of high torques.

# A real all-in-one rack.

## 950/9 Hex-Plus Multicolour 3 L-key set, metric, BlackLaser



9-piece set, in a rack that can be set upright on the table or hung on the wall thanks to the 9109 wall holder/base; integrated removable clip 9539 for mobile use, integrated removable magnet 9538 for magnetising and demagnetising tool tips

**Application:** Hexagonal socket screws

**Design:** BlackLaser surface, with hose sleeve. All L-keys are easily accessible due to their colour coding and size markings.

**Tip:** Hex-Plus, hexagonal ball tip at the long arm

05133165001	
○	950 SPKL Multicolour 1x 1.5x90; 1x 2.0x101; 1x 2.5x112; 1x 3.0x123; 1x 4.0x137; 1x 5.0x154; 1x 6.0x172; 1x 8.0x195; 1x 10.0x224
	9539
	9109
	9538

## 950/9 Hex-Plus 8 L-key set, metric, chrome-plated



9-piece set, in a rack that can be set upright on the table or hung on the wall thanks to the 9109 wall holder/base; integrated removable clip 9536 for mobile use, integrated removable magnet 9538 for magnetising and demagnetising tool tips

**Application:** Hexagonal socket screws

**Design:** Chrome-plated

**Tip:** Hex-Plus, hexagonal ball tip at the long arm

05022102001	
○	950 PKL 1x 1.5x90 <sup>1)</sup> ; 1x 2.0x100; 1x 2.5x112; 1x 3.0x126; 1x 4.0x140; 1x 5.0x160; 1x 6.0x180; 1x 8.0x200; 1x 10.0x219
	9109
	9536
	9538

<sup>1)</sup> Regular hexagon





## Hex-Plus



Hexagon screws can endure a problem because the contact surfaces delivering the power from the conventional tool, is transferred to the screw via very small surface areas. The consequence: the screw can become damaged (rounding out). Hex-Plus tools have a greater contact surface that

prevents this from happening! At the same time, as much as 20 % more torque can be applied. Good to know: Hex-Plus tools fit into every standard hexagon socket screw!

## Clever storage for L-keys



The rack for the L-keys can be set up on the table or hung on the wall.

## Clip for take-away



The clip is removable; so the L-keys can also be taken out and about.

## Removable magnetiser

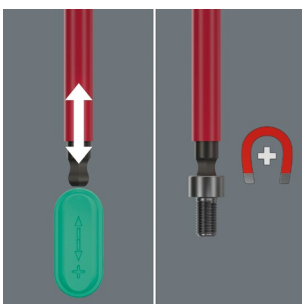

The rack includes a removable magnetiser that can be used to magnetise (and demagnetise) screws and tool tips.



## 950/9 Hex-Plus Multicolour Imperial 3 L-key set, imperial, BlackLaser



9-piece set, in a 2-component clip

**Application:** Hexagonal socket screws

**Design:** BlackLaser surface, with hose sleeve. All L-keys are easily accessible due to their colour coding and size markings.

**Tip:** Hex-Plus, hexagonal ball tip at the long arm

05022641001	
	<b>950 SPKS Multicolour</b>
	1x 5/64"x50; 1x 3/32"x56; 1x 1/8"x63; 1x 5/32"x71; 1x 3/16"x80; 1x 7/32"x90; 1x 1/4"x100; 1x 5/16"x112; 1x 3/8"x125







## 9532 Chain riveter set for workshops



## For the weakest chain link.

20-piece set

One Wera Zyklop Mini 1 bit ratchet, drop-forged solid steel design; suitable for mounting bits with 1/4" external hexagon drive as per DIN ISO 1173-C 6.3 and E 6.3 and Wera connection series 1 and 4, one 816 R bitholding screwdriver, one chain riveter, one chain fastener, spare parts set chain riveter pin, one chain lock tool, 10 bits with 89 mm length, 2 bits with 25 mm length, one robust folding pouch

05136042001		
●	8001 A	1x 1/4"x87.0
●	816 R	1x 1/4"x119
+	851/4 Z	1x PH 1x89; 1x PH 2x89
+	867/4 Z TORX®	1x TX 10x89; 1x TX 25x89
○	840/4 Z	1x 2.0x89; 1x 2.5x89; 1x 3.0x89; 1x 4.0x89; 1x 5.0x89; 1x 6.0x89 <sup>1)</sup>
○	840/1 Z	1x 5.0x25; 1x 8.0x25
9512 Chain-Hook		
9513 Chain Tool		
9533 Quick-release bike chain tool		
9534 3x 15.0		

<sup>1)</sup> Hexagonal blade

### Chain tools

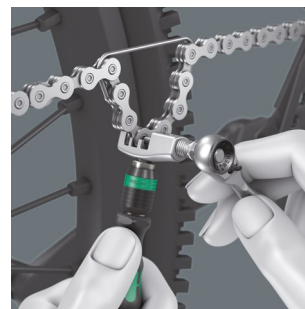

With the included chain tools, chains can be loosened and reconnected; for opening and closing bicycle chains. Suitable for single-speed chains, up to 12-speed.

### Chain lock tool

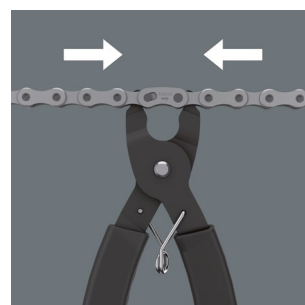

The chain lock tool makes it easier to open lockable chain locks for cleaning or replacing chain links.

# 9540 Kraffform XL Bottle Set



17-piece screwdriver set; including refillable Elite Fly drinking bottle.

2 chiseldrivers for screwdriving, chiseling and mortising, 2 Kraffform screwdrivers with Lasertip for Phillips screws, 2 Kraffform screwdrivers for TORX screws, 2 Kraffform VDE screwdrivers, 160 iS with reduced blade diameter and integrated protective insulation for slotted screws, 162 i with Lasertip, 6 BITorsion bits, one universal bit holder, one Bit-Check, empty.

05100028001	
	9541 Drinking 1x 550 bottle
⊖	932 A 1x 1.0x5.5x100; 1x 1.2x7.0x125
⊕	350 1x PH 1x80; 1x PH 2x100
⊗	367 TORX® 1x TX 20x100; 1x TX 25x100
⊖	160 iS VDE 1x 0.6x3.5x100
⊕	162 i VDE PH 1x PH 2x100
	Bit-Check 7 Tool finder 1, empty
⊗	893/4/1 K 1x 1/4"x50
⊕	851/1 BTZ 1x PH 2x25
⊕	855/1 BTZ 1x PZ 1x25; 1x PZ 2x25
⊗	867/1 TORX® 1x TX 15x25; 1x TX 20x25; 1x TX 25x25 BTZ

## Drinking bottle for outdoor activities



Elite Fly drinking bottle in Wera design with 550 ml capacity. Perfect for outdoor activities. Also fits in all standard bicycle water bottle cages.

## Bits and universal bit holder in Bit-Check

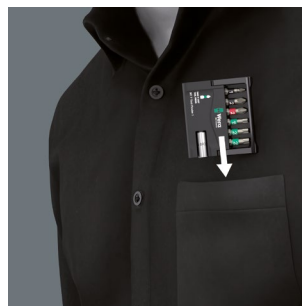

The Bit-Checks by Wera are extremely compact and are therefore the ideal companion for mobile applications.



## Bit-Check 30 TX Universal 1 SB



**NOW AVAILABLE  
IN RETAIL PACKAGING**

1 universal bit holder with stainless steel sleeve, retaining ring, and strong permanent magnet, 29 bits, tough, for universal use.

05057900001	
1x Bit-Check 30 TX Universal 1	
● 899/4/1	1x 1/4"x50
♻ 867/1 TORX®	3x TX 10x25; 5x TX 15x25; 8x TX 20x25; 7x TX 25x25; 4x TX 30x25; 2x TX 40x25

## Bit-Check 30 Wood 2 SB



**NOW AVAILABLE  
IN RETAIL PACKAGING**

1 universal bit holder with stainless steel sleeve, retaining ring, and strong permanent magnet, 29 bits, tough, for universal use.

05057438001	
1x Bit-Check 30 Wood 2	
● 899/4/1	1x 1/4"x50
⊕ 851/1 Z	1x PH 2x25
⊕ 855/1 Z	2x PZ 1x25; 5x PZ 2x25; 2x PZ 3x25
♻ 867/1 TORX®	3x TX 10x25; 4x TX 15x25; 4x TX 20x25; 4x TX 25x25; 3x TX 30x25; 1x TX 40x25

## Bit-Check 30 Metal 1 SB



**NOW AVAILABLE  
IN RETAIL PACKAGING**

1 universal bit holder with stainless steel sleeve, retaining ring, and strong permanent magnet, 29 bits, tough, for universal use.

05057440001	
1x Bit-Check 30 Metal 1	
● 899/4/1	1x 1/4"x50
⊕ 851/1 Z	3x PH 1x25; 3x PH 2x25; 2x PH 3x25
⊕ 855/1 Z	3x PZ 1x25; 3x PZ 2x25; 3x PZ 3x25
♻ 867/1 TORX®	1x TX 10x25; 1x TX 15x25; 1x TX 20x25; 1x TX 25x25; 1x TX 30x25; 1x TX 40x25
⊖ 800/1 Z	1x 0.6x4.5x25; 1x 1.0x5.5x25; 1x 1.2x6.5x25
○ 840/1 Z	1x 4.0x25; 1x 5.0x25; 1x 6.0x25

### Universal holder with stainless steel sleeve



The retaining ring and the strong permanent magnet ensure a particularly secure fitting of the bit in the holder.

### At the workplace



The Bit-Checks can be positioned upright at the workplace so the tool is always quickly to hand.

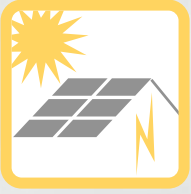



## 9524 photovoltaic mounting tool set 1



7-piece tool set for installing photovoltaic systems. One 7442 adjustable torque screwdriver (pistol handle) for the measuring range 3.0-6.0 Nm. One 889/4/1 F Rapidaptor bitholder with fast-rotating function for a particularly quick return movement without having to remove the tool during clockwise torque operation. One 6003 Joker ring spanner. 2 installation tools for MC4 solar connectors (Multi-Contact). One socket 1/2" (with side wire cutout) size 17 for installing panel connectors. One tool shaft (adapter 1/4" to 1/2") for manually operated square head sockets.

05136043001		
●	7400 pistol grip	1x 7442, 3,0-6,0 Nm
●	8790 HMC Deep with cutout	1x 17,0x76,0
○ ○	870/4 A	1x 1/4"x1/2"x72
○ ○	889/4/1 F	1x 1/4"x64
	6003 Joker	1x 17x190
	9108	2x 115
	Hook and Loop Fastener Strip 120	1x 50,0x120,0

## 9108/2 PV Set of installation tools for MC4 Solar connectors



**Application:** For tightening and loosening the cable connection and to release the locking of the plug connection; MC4 solar connector (Multi-Contact).

**Design:** Glass fibre reinforced plastic

05136700001		
	9108	2x 115

## For installing solar systems



The set includes the screwdriving tools required for installing solar systems such as torque wrenches, ring spanners and installation tools for solar connectors.

## Simple setting

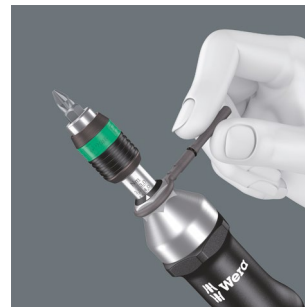

Simple setting of the required torque by hand.

## Installation tool for MC4 solar connectors

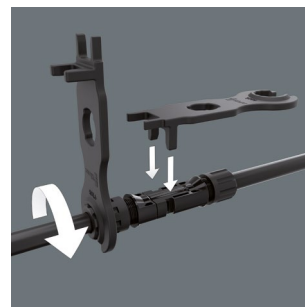

For tightening and loosening the cable connection and to release the locking of the plug connection.

## Socket wrench with side wire cutout



Particularly suitable for mounting temperature sensors, thermo switches and other components that are cabled from the top and sides.



## 9530 Torque wrench set for heat pumps/air conditioning



4-piece set; in surface-friendly, compact and extremely robust textile box. Small size and low weight for better mobility.

One Click-Torque X 7 torque wrench with 14x18 mm mounting for insert tools, measuring range 10-100 Nm, accuracy  $\pm 4\%$  of the set value, as per DIN EN ISO 6789-1:2017-07, for clockwise and anti-clockwise torque-control; easy setting and saving of the required torque, with audible and tactile locking when the scale values are reached (fine scale only in Newton meters), audible and tactile release mechanism when the set torque value is reached, ergonomic 2-component handle, 3 self-setting Joker 7880 exchangeable insert spanners with ratchet functionality.

Part Number	Description
05136076001	Click-Torque X 7 1x 14x18, 10-100 Nm
7880 Joker XXL	1x 14x18x24-32 ( $15/16''-1\ 1/4''$ )x113,5
7880 Joker XL	1x 14x18x19-24 ( $3/4''-15/16''$ )x95,0
7880 Joker L	1x 14x18x16-19 ( $5/8''-3/4''$ )x85,5

## For air conditioning lines



With the 9530 set, the screw connections used for refrigeration and air conditioning systems as well as heat pump lines can be properly tightened.



## Automatically and continuously self-setting

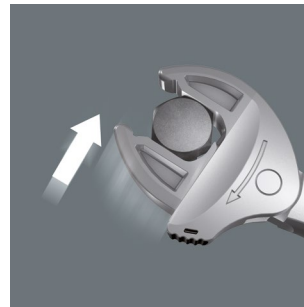

With its automatically and continuously gripping parallel jaws the Joker 7880 covers all dimensions within the potential operative range. The tool finds the required size by itself when attaching it to the bolt or screw.



## Joker 7880: Ratchet mechanism for quick working

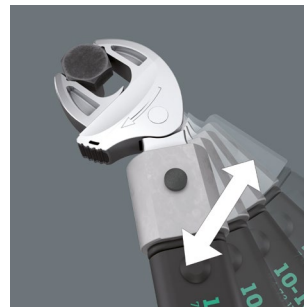

The ratchet function in the mouth sees to fast and consistent screwdriving without removing the tool.

## Click-Torque X 7 Torque wrench for insert tools, 10-100 Nm



**Application:** For clockwise and anti-clockwise torque-control

**Precision:** Accuracy  $\pm 4\%$  of the set value, as per DIN EN ISO 6789-1:2017-07

**Design:** With mounting for exchangeable insert tools 14x18 mm; easy setting and saving of the required torque, with audible and tactile locking when the scale values are reached (fine scale only in Newton meters), audible and tactile release mechanism when the set torque value is reached

**Handle:** Ergonomic 2-component handle

Part Number	Scale		Scale		S <sub>k</sub>	l <sub>k</sub>	S <sub>1</sub>	S <sub>2</sub>	S <sub>3</sub>	S <sub>4</sub>	S <sub>5</sub>	S <sub>6</sub>	S <sub>7</sub>	S <sub>8</sub>	S <sub>9</sub>
	Nm	lbf. ft.	mm	mm											
05075657001	10-100	0.5 - 7-73	372	25.5	329.0	140	47	29	20	14 41/64"	5 33/64"	1 27/32"	1 9/64"	25/32"	

S<sub>k</sub> = Actual dimension of the test attachment; l<sub>k</sub> = Distance from the force application point to the test device axis



### 7880 Joker XXL Self-setting insert spanner for wrench sizes 24-32 mm, 14x18mm

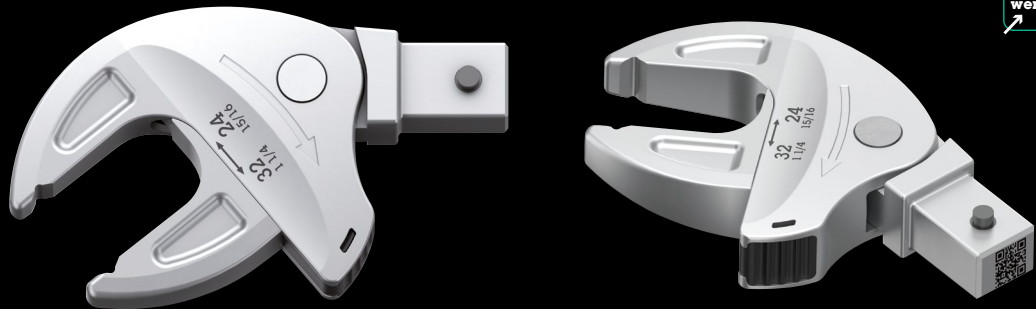

**Application:** Hexagonal screw heads and bolts  
**Drive:** 14x18 mm; for torque wrenches of the Click-Torque X and XP series with 14x18 mm mounting  
**Design:** Self-setting spanner with ratchet functionality; open end adjustable in size, parallel smooth jaws; with 30° return angle via the corner-width prisms in the jaw

	mm	mm	mm	mm	mm	mm	mm	
05020173001	14x18	24-32	24,0	62,2	15/16"-	15/16"	62,2	113,5
			27,0	68,0	1 1/4"	31/32"	63,9	
			30,0	70,2		1"	65,4	
			32,0	70,4		1 1/16"	66,4	
						1 1/8"	69,5	
						1 3/16"	70,1	
				1 1/4"	70,2			

### 7880 Joker XL Self-setting insert spanner for wrench sizes 19-24 mm, 14x18mm

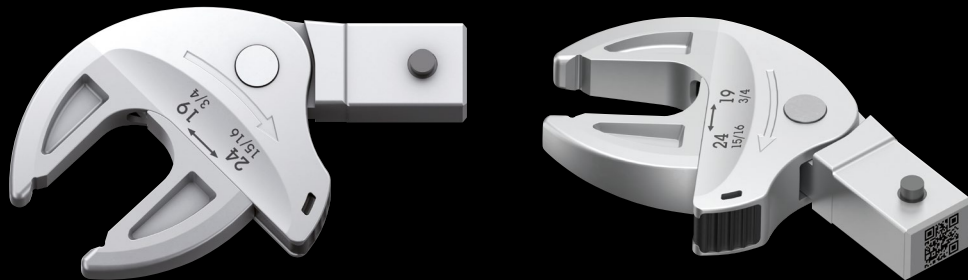

**Application:** Hexagonal screw heads and bolts  
**Drive:** 14x18 mm; for torque wrenches of the Click-Torque X and XP series with 14x18 mm mounting  
**Design:** Self-setting spanner with ratchet functionality; open end adjustable in size, parallel smooth jaws; with 30° return angle via the corner-width prisms in the jaw

	mm	mm	mm	mm	mm	mm	mm	
05020172001	14x18	19-24	19,0	51,6	3/4"-	3/4"	51,6	95,0
			20,0	53,6	15/16"	25/32"	53,3	
			21,0	55,4		1 3/16"	54,7	
			22,0	56,7		7/8"	56,7	
			24,0	56,7		15/16"	56,7	

### 7880 Joker L Self-setting insert spanner for wrench sizes 16-19 mm, 14x18mm

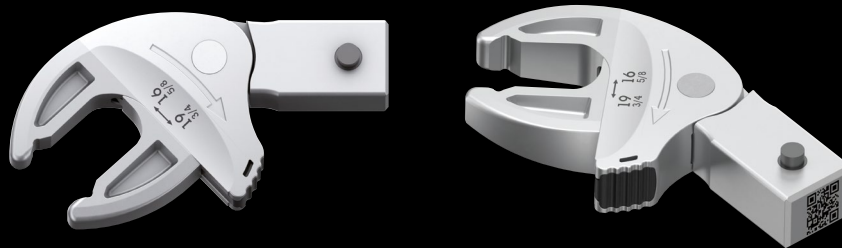

**Application:** Hexagonal screw heads and bolts  
**Drive:** 14x18 mm; for torque wrenches of the Click-Torque X and XP series with 14x18 mm mounting  
**Design:** Self-setting spanner with ratchet functionality; open end adjustable in size, parallel smooth jaws; with 30° return angle via the corner-width prisms in the jaw

	mm	mm	mm	mm	mm	mm	mm	
05020171001	14x18	16-19	16,0	44,6	5/8"-3/4"	5/8"	44,4	85,5
			17,0	46,7		11/16"	47,3	
			18,0	48,2		3/4"	49,1	
			19,0	49,1				

# New solution for setting the torque correctly

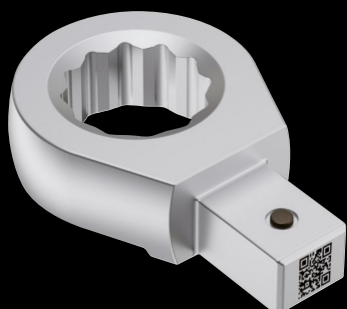

## The problem:

Insert tools for torque tools have different geometries, which changes the required torque value. To get the correct setting value, the geometries need entering into a formula: complicated and often not feasible at the workplace.

## The solution:

QR codes (containing the required values) on torque tools and insert tools. Scan the QR code → enter the required torque value in Nm → read the actual Nm to be set: done. And all that without an app!

[www.wera.de/torque-advisor](http://www.wera.de/torque-advisor)



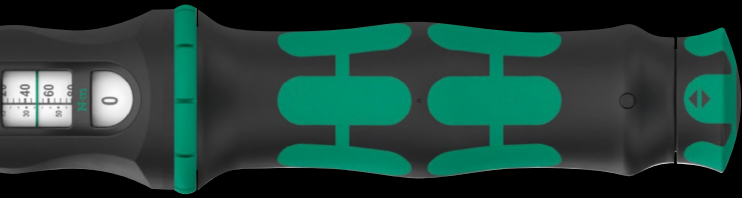

## Calibration of Click-Torque X wrenches

The tool was calibrated by means of a test adapter whose pitch is designated "S<sub>k</sub>". If the gauge of the tool you are using deviates from the length "S<sub>k</sub>", the actual release torque will change according to the formula.

$$M_s = \frac{M_A \times l_k}{l_k + (S - S_k)}$$

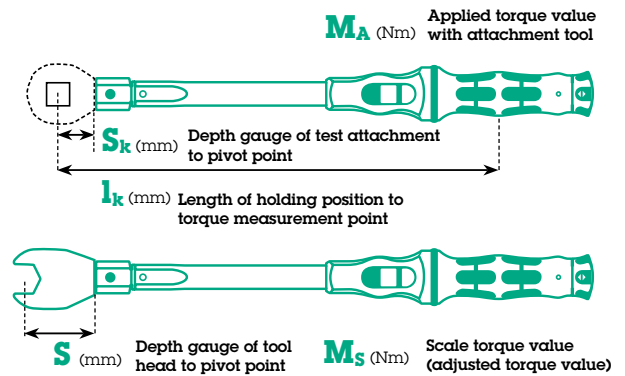

## NEW

Simple and error-free determination of the torque value



The laser-engraved, abrasion-proof QR code makes it easier to determine the correct torque value depending on the torque wrench and insert tool used. Simply scan with your smartphone and tablet (if available, both QR codes: Torque wrench and insert tool). A website opens automatically which recognizes the scanned tools (no app needed!). Then enter the required torque value; the corrected value is determined automatically. No need to use formulas/calculations.



## Safe-Torque A 1 SHK Set 1, 1/4" square head, 2-12 Nm



### Slide-over mechanism prevents application of excessive torques



The Safe-Torque A 1 torque wrench is equipped with a slide-over mechanism. Once the set torque value has been reached, the tool cannot be overtightened, so that excessive torque cannot be applied.



### Torque Lock function



The torque function can be deactivated. The Safe-Torque torque wrench can then also be used as a standard ratchet with high loosening moments and for applications with defined angles of rotation.



### For clockwise and counterclockwise operation



The Safe-Torque torque wrench is suitable for clockwise and counterclockwise operation with a set torque. When the Torque Lock function is deactivated, tightening and loosening is enabled without torque.



20-piece set; in surface-friendly, compact and extremely robust textile box. Small size and low weight for better mobility.

One Safe-Torque A 1 torque wrench with 1/4" square head drive, measuring range 2-12 Nm; for controlled clockwise and counterclockwise torque operation; tightening and loosening with or without torque, disengageable torque function (Torque Lock function); 72 teeth; low return angle of 5°; easy setting and saving of the required torque, with audible and tactile locking when the scale values are reached, slip-over release mechanism when the set torque is reached; ergonomic 2-component handle; 8 Zyklop sockets, 9 Zyklop bit sockets (hexagonal socket, TORX®), 1 Zyklop extension with fast-rotating sleeve, short

05136073001		
⊕	Safe-Torque A 1	1x 1/4", 2-12 Nm
⊙	8790 HMA	1x 5,5x23,0; 1x 6,0x23,0; 1x 7,0x23,0; 1x 8,0x23,0; 1x 10,0x23,0; 1x 11,0x23,0; 1x 12,0x23,0; 1x 13,0x23,0
⊗	8767 A HF	1x TX 15x28,0; 1x TX 20x28,0; 1x TX 25x28,0; 1x TX 30x28,0
⊕	8740 A HF	1x 3,0x28,0; 1x 4,0x28,0; 1x 5,0x28,0; 1x 6,0x28,0; 1x 8,0x28,0
	Belt A 0/9	1x 39,0x238,0
⊕ ⊙	8794 SA	1x 1/4"x75,0
	Hook and Loop Fastener Strip 240	1x 50,0x240,0

## 9529 C SB 1/2" Step wrench



**Drive:** 1/2"

**Application:** For all standard drain fittings, radiator valves, thermostats, etc.

**Design:** 5 steps: 3/8", 7/16", 1/2", 16 and 21 mm; chrome vanadium steel, matt chrome plated

05136074001	mm	88,0
-------------	----	------



## Wera 2go SHK 1 Tool set for plumbing, heating and air conditioning



### Wera 2go SHK 1 (plumbing, heating and air conditioning)



Extensive 30-piece tool set in the compact Wera 2go 2 tool container for mobile HVAC applications.

### Step wrench with 5 steps

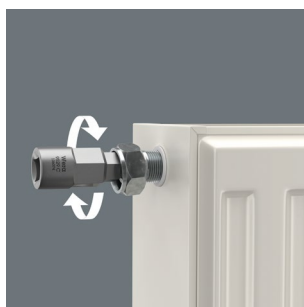

The step wrench ( $\frac{1}{2}$ " is suitable for all standard drain fittings, radiator valves, thermostats, etc. 5 steps ( $\frac{3}{8}$ ",  $\frac{7}{16}$ ",  $\frac{1}{2}$ ", 16 and 21 mm).

30-piece set, tool set for HVAC services; one rigid, robust Wera 2go 2 tool container with hook and loop fastener system to attach other Wera 2go components and textile Wera boxes and pouches with hook and loop fasteners, including one removable quiver with handle and adjustable hook and loop dividers for up to 5 inner compartments, one chiseldriver for screwdriving, chiseling and mortising, 4 VDE screwdrivers, 2 socket screwdrivers with hollow shaft, one Wera Zyklus Metal Switch ratchet ( $\frac{1}{2}$ "), 4 Zyklus sockets ( $\frac{1}{2}$ "), one Belt C (textile belt), for up to 6 socket wrench inserts, empty, 4 Joker double spanners, one 950/9 Hex-Plus L-key set for hexagonal socket screws, one Wera Radiator step wrench, 1x KNIPEX® combination pliers (160 mm, Art. no. 03 01 160), 1x KNIPEX® COBRA® water pump pliers 250 mm (Art. no. 87 11 250), one KNIPEX® diagonal insulation stripper (Art. no. 14 26 160), one KNIPEX® pro wrench for all standard shut-off systems (Art. no. 00 11 04), one PUK® hand saw (Art. no. 2200), one Lyra® construction marker (Art. no. 4494202), one STABILA® spirit level (type 70, 30 cm, Art. no. 02281), one STABILA® wooden folding meter (type 607, 2 m, light yellow, Art. no. 01104), one PICARD® riveting hammer 400 g, German shape (Art. no. 000101-0400), one BESSEY® bladed jack-knife DBKPH-EU.

05136071001	1x	Wera 2go 2
	1x	932 A Screwdriver for slotted screws, 1.2 x 7.0 x 125 mm
	1x	395 HO Nutdriver, 10.0 mm x 90 mm
	1x	395 HO Nutdriver, 13.0 x 90 mm
	1x	1060 i VDE-insulated Kraftform slotted screwdriver, 0.6 x 3.5 x 100 mm
	1x	1060 i VDE-insulated Kraftform slotted screwdriver, 1.0 x 5.5 x 125 mm
	1x	1062 i PH VDE-insulated Kraftform Phillips-head screwdriver, PH 1 x 80 mm
	1x	1062 i PH VDE-insulated Kraftform Phillips-head screwdriver, PH 2 x 100 mm
	1x	8004 C Zyklus Metal Ratchet with switch lever and $\frac{1}{2}$ " drive, 281 mm
	1x	8790 HMC Zyklus socket with $\frac{1}{2}$ " drive, 10.0 mm
	1x	8790 HMC Zyklus socket with $\frac{1}{2}$ " drive, 13.0 mm
	1x	8790 HMC Zyklus socket with $\frac{1}{2}$ " drive, 17.0 mm
	1x	8790 HMC Zyklus socket with $\frac{1}{2}$ " drive, 19.0 mm
	1x	Belt C (textile belt), 6 location, unloaded
	1x	6002 Joker Double Open-Ended Wrench, 10 + 13 x 167 mm
	1x	6002 Joker Double Open-Ended Wrench, 17 + 19 x 235 mm
	1x	6002 Joker double spanner, 24 + 27 x 280 mm
	1x	6002 Joker double spanner, 30 + 32 x 305 x 305 mm
	1x	950/9 Hex-Plus 2
	1x	9529 C SB $\frac{1}{2}$ " Step wrench
	1x	KNIPEX® Water pump pliers COBRA® 250mm 87 11 250
	1x	KNIPEX® Combination pliers 160mm 03 01 160
	1x	KNIPEX® Diagonal insulation stripper 14 26 160
	1x	KNIPEX 001104 Pro wrench for standard shut-off systems
	1x	STABILA® Spirit level type 70, 30 cm, 02281
	1x	STABILA® Wooden folding rule type 607, 2 m, yellow, 01104
	1x	PICARD® Fitter's hammer 400 g, German shape, 000101-0400
	1x	PUK® 2200 Hand saw frame
	1x	BESSEY® blades DBKPH-EU flick knife
	1x	Lyra® Construction marker DRY PROF1 4494202

## Kraftform Kompakt 400 RA SHK Set 1



19-piece set

Textile box with one 416 RA T-handle bitholding screwdriver with ratchet functionality and Rapidaptor quick-release chuck, 1 Kraftform bitholding screwdriver 816 R with Rapidaptor quick-release chuck, 15 tough bits, 1/4", 89 mm length, 2 nutsetters, magnetic

05136072001		
●	416 RA	1x 1/4"x45
●	816 R	1x 1/4"x119
+	851/4 Z	1x PH 2x89
+	855/4 Z	1x PZ 2x89
+	855/4 PZ/S	1x # 1x70; 1x # 2x70
+	867/4 Z TORX®	1x TX 15x89; 1x TX 20x89; 1x TX 25x89; 1x TX 30x89
○	840/4 Z	1x 2,0x89; 1x 2,5x89; 1x 3,0x89; 1x 4,0x89; 1x 5,0x89; 1x 6,0x89 <sup>1)</sup> ; 1x 8,0x89 <sup>1)</sup>
●	869/4 M	1x 8,0x50,0; 1x 10,0x50,0
	Hook and Loop Fastener Strip 120	1x 50,0x120,0

<sup>1)</sup> Hexagonal blade

### Ratchet mechanism in the handle

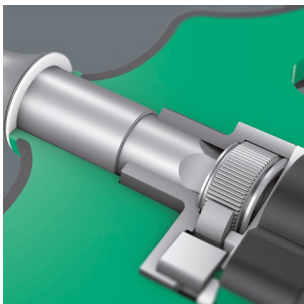

The ratchet mechanism of the 416 RA T-handle bitholding screwdriver is completely embedded in the handle. The compact shape of the tool allows convenient working.

## 454/5 HF SHK Set 1 Screwdriver set T-handle screwdriver Hex-Plus with holding function

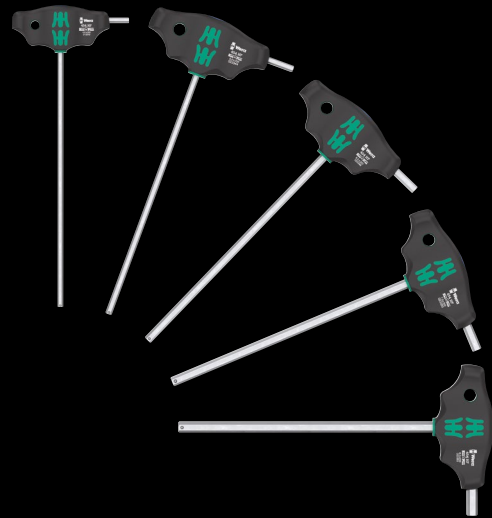
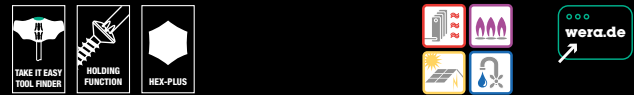

**Application:** Hexagonal socket screws, T-handle screwdrivers with holding function at the long arm

**Design:** 5 Hex-Plus T-handle screwdrivers with "Take it easy" Tool finder: Colour coding by profile (blue = hexagonal socket) and size stamping

05136070001		
○	454 HF	1x 4x200; 1x 5x200; 1x 6x200; 1x 7x200; 1x 8x200

## Bit-Check 6 SHK 1 SB



6 bits, torsion shape (T) against premature wear, tough (Z), for universal use. Assortment particularly suitable for plumbing, heating and air conditioning operations.

05073631001		
<b>1x Bit-Check 6 SHK 1</b>		
+	851/4 TZ	1x PH 1x50
+	867/4 Z TORX®	1x TX 15x50; 1x TX 20x50; 1x TX 25x50
○	840/4 Z	1x 5.0x50; 1x 6.0x50 <sup>1)</sup>

<sup>1)</sup> Hexagonal blade



## Kraftform Kompakt 27 XL SHK 1



**Application:** Suitable for bits with 1/4" external hexagon drive as per DIN ISO 1173-C 6.3 and E 6.3 and Wera connection series 1 and 4

**Design:** 300 mm long rigid blade; with compact stainless steel holder and strong permanent magnet. Secure bitholding function thanks to locking mechanism.

**Handle:** Kraftform with anti-roll protection, multi-component, integrated bit magazine

05136075001	
+	851/1 Z 1x PH 2x25
+	867/1 TORX® 1x TX 15x25; 1x TX 20x25; 1x TX 25x25
○	840/1 Z 1x 5,0x25; 1x 6,0x25
●	394 S 1x 1/4"x300

## Kraftform Kompakt 27 XL Universal 1



**Application:** Suitable for bits with 1/4" external hexagon drive as per DIN ISO 1173-C 6.3 and E 6.3 and Wera connection series 1 and 4

**Design:** 300 mm long rigid blade; with compact stainless steel holder and strong permanent magnet. Secure bitholding function thanks to locking mechanism.

**Handle:** Kraftform with anti-roll protection, multi-component, integrated bit magazine

05051028001	
+	851/1 BTZ 1x PH 1x25; 1x PH 2x25
+	855/1 BTZ 1x PZ 2x25
+	867/1 TORX® 1x TX 15x25; 1x TX 20x25; 1x TX 25x25
○	BTZ
●	394 S 1x 1/4"x300

## 300 mm long blade



The 300 mm long blade makes it possible to reach even low lying couplings.

## Secure hold and easy removal



Secure bit holding feature due to locking mechanism. With strong permanent magnet.

## Kraftform Kompakt 27 XL Universal Imperial Set 1

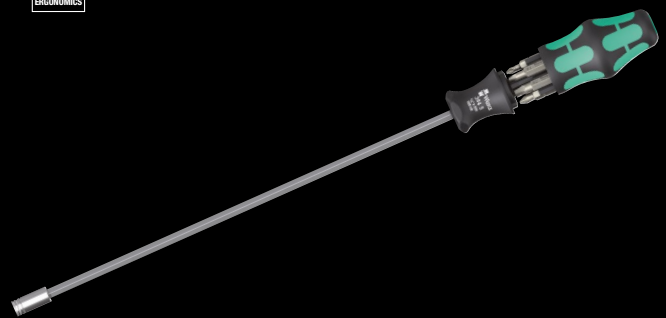

**Application:** Suitable for bits with 1/4" external hexagon drive as per DIN ISO 1173-C 6.3 and E 6.3 and Wera connection series 1 and 4

**Design:** 300 mm long rigid blade; with compact stainless steel holder and strong permanent magnet. Secure bitholding function thanks to locking mechanism.

**Handle:** Kraftform with anti-roll protection, multi-component, integrated bit magazine

05051032001	
+	851/1 Z 1x PH 1x25; 1x PH 2x25
+	800/1 Z 1x 1,0x5,5x25; 1x 1,2x6,5x25
○	868/1 Z 1x # 1x25; 1x # 2x25
●	394 S 1x 1/4"x300

No liability for printing errors or mistakes shall be assumed.



Wera Werkzeuge GmbH  
Korzerter Straße 21-25  
D-42349 Wuppertal

+49 (0)2 02 / 40 45-0  
info@wera.de  
www.wera.de

Wera Tools Inc. (North America)  
4129 Harvester Rd, Unit H  
Burlington, Ontario  
Canada, L7L 5M3

1-800-267-55 41  
info@weratools.com  
www.weratools.com

Wera Tools (UK) LTD.  
Railway View  
Clay Cross, Chesterfield  
Derbyshire, S45 9FR

Phone: +44 (0)1246 / 277756  
Fax: +44 (0)1246 / 273335  
eMail: queries@wera-tools.co.uk  
Internet: www.wera-tools.co.uk

