

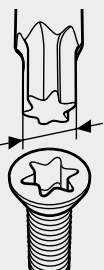

Tabelle di misura dei profili

Utensili con profili TORX® esterno per viti con impronta TORX®

		
TX 1		0,84
TX 2		0,94
TX 3		1,12
TX 4		1,30
TX 5		1,37
TX 6		1,65
TX 7		1,97
TX 8		2,30
TX 9		2,48
TX 10		2,72
TX 15		3,26
TX 20		3,84
TX 25		4,40
TX 27		4,96
TX 30		5,49
TX 40		6,60
TX 45		7,77
TX 50		8,79
TX 55		11,17
TX 60		13,20
TX 70		15,49

Utensili con profili TORX PLUS® esterno per viti con impronta TORX PLUS® femmina

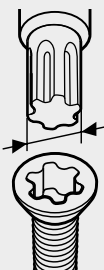
		
1 IP		0,84
2 IP		0,95
3 IP		1,13
4 IP		1,29
5 IP		1,41
6 IP		1,69
7 IP		1,97
8 IP		2,29
9 IP		2,48
10 IP		2,72
15 IP		3,25
20 IP		3,84
25 IP		4,39
27 IP		4,95
30 IP		5,49
40 IP		6,60
45 IP		7,77
50 IP		8,79
55 IP		11,16
60 IP		13,20
70 IP		15,48

Utensili con profilo TORQ-SET® esterno per viti con impronta TORQ-SET®

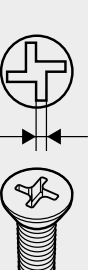
		
0		0,43
1		0,43
2		0,43
3		0,48
4		0,56
5		0,63
6		0,71
8		0,84
10		0,96
1/4"		1,27
5/16"		1,60
3/8"		1,90
7/16"		2,23
1/2"		2,54

Utensili con profilo TRI-WING® esterno per viti con impronta TRI-WING®

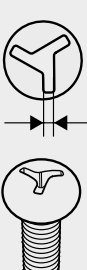
		
0		0,45
1		0,57
2		0,75
3		0,95
4		1,08
5		1,23
6		1,54
7		1,87
8		2,17
9		2,48
10		2,78

Utensili con profilo esterno XZN per viti con impronta XZN

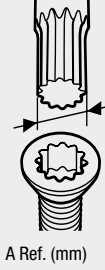
		
M 4		3,83
M 5		4,80
M 6		6,00
M 8		7,20
M 10		9,60
M 12		11,41
M 14		13,22
M 16		15,63
M 18		16,85
M 20		19,25

Utensili con profilo esterno quadro maschio per viti con impronta quadra

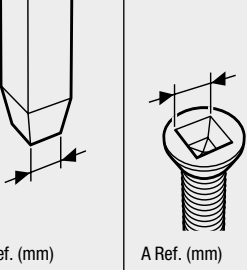
		
00		1,27
0		1,78
1		2,31
2		2,85
3		3,37
4		4,84

Utensili con profilo esterno tenditore per viti con impronta a 2 fori

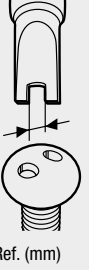
		
4		1,52
6		2,41
8		2,79
10		3,30